

# **my-d™ move** **my-d™ move NFC**

**SLE 66R01P**  
**SLE 66R01PN**

Intelligent 1216 bit EEPROM with  
Contactless Interface compliant to  
ISO/IEC 14443-3 Type A and support of  
NFC Forum™ Type 2 Tag Operation

## Data Book

2011-11-24

## Chip Card & Security

**Edition 2011-11-24**

**Published by  
Infineon Technologies AG  
81726 Munich, Germany**

**© 2011 Infineon Technologies AG  
All Rights Reserved.**

### **Legal Disclaimer**

The information given in this document shall in no event be regarded as a guarantee of conditions or characteristics. With respect to any examples or hints given herein, any typical values stated herein and/or any information regarding the application of the device, Infineon Technologies hereby disclaims any and all warranties and liabilities of any kind, including without limitation, warranties of non-infringement of intellectual property rights of any third party.

### **Information**

For further information on technology, delivery terms and conditions and prices, please contact the nearest Infineon Technologies Office ([www.infineon.com](http://www.infineon.com)).

### **Warnings**

Due to technical requirements, components may contain dangerous substances. For information on the types in question, please contact the nearest Infineon Technologies Office.

Infineon Technologies components may be used in life-support devices or systems only with the express written approval of Infineon Technologies, if a failure of such components can reasonably be expected to cause the failure of that life-support device or system or to affect the safety or effectiveness of that device or system. Life support devices or systems are intended to be implanted in the human body or to support and/or maintain and sustain and/or protect human life. If they fail, it is reasonable to assume that the health of the user or other persons may be endangered.

**my-d™ move / my-d™ move NFC - SLE 66R01P / SLE 66R01PN Data Book**  
The information in this document is subject to change without notice.

**Revision History: Current Version 2011-11-24**

**Previous Release: Preliminary 2011-11-18**

Page	Subjects (major changes since last revision)
All	Editorial changes; removed "Preliminary" status; update of figures (memory organization)

**Trademarks of Infineon Technologies AG**

BlueMoon™, COMNEON™, C166™, CROSSAVE™, CanPAK™, CIPOS™, CoolMOS™, CoolSET™, CORECONTROL™, DAVE™, EasyPIM™, EconoBRIDGE™, EconoDUAL™, EconoPACK™, EconoPIM™, EiceDRIVER™, EUPEC™, FCOS™, HITFET™, HybridPACK™, ISOFACE™, I²RF™, IsoPACK™, MIPAQ™, ModSTACK™, my-d™, NovalithIC™, OmniTune™, OptiMOS™, ORIGAT™, PROFET™, PRO-SIL™, PRIMARION™, PrimePACK™, RASIC™, ReverSave™, SatRIC™, SensoNor™, SIEGET™, SINDRION™, SMARTi™, SmartLEWIS™, TEMPFET™, thinQ!™, TriCore™, TRENCHSTOP™, X-GOLD™, XMM™, X-PMU™, XPOSYS™.

**Other Trademarks**

Advance Design System™ (ADS) of Agilent Technologies, AMBA™, ARM™, MULTI-ICE™, PRIMECELL™, REALVIEW™, THUMB™ of ARM Limited, UK. AUTOSAR™ is licensed by AUTOSAR development partnership. Bluetooth™ of Bluetooth SIG Inc. CAT-iq™ of DECT Forum. COLOSSUS™, FirstGPS™ of Trimble Navigation Ltd. EMV™ of EMVCo, LLC (Visa Holdings Inc.). EPCOS™ of Epcos AG. FLEXGO™ of Microsoft Corporation. FlexRay™ is licensed by FlexRay Consortium. HYPERTERMINAL™ of Hilgraeve Incorporated. IEC™ of Commission Electrotechnique Internationale. IrDA™ of Infrared Data Association Corporation. ISO™ of INTERNATIONAL ORGANIZATION FOR STANDARDIZATION. MATLAB™ of MathWorks, Inc. MAXIM™ of Maxim Integrated Products, Inc. MICROTEC™, NFC Forum™ is trademark of Near Field Communication Forum, NUCLEUS™ of Mentor Graphics Corporation. Mifare™ of NXP. MIPI™ of MIPI Alliance, Inc. MIPS™ of MIPS Technologies, Inc., USA. muRata™ of MURATA MANUFACTURING CO., MICROWAVE OFFICE™ (MWO) of Applied Wave Research Inc., OmniVision™ of OmniVision Technologies, Inc. Openwave™ Openwave Systems Inc. RED HAT™ Red Hat, Inc. RFMD™ RF Micro Devices, Inc. SIRIUS™ of Sirius Sattelite Radio Inc. SOLARIS™ of Sun Microsystems, Inc. SPANSION™ of Spansion LLC Ltd. Symbian™ of Symbian Software Limited. TAIYO YUDEN™ of Taiyo Yuden Co. TEAKLITE™ of CEVA, Inc. TEKTRONIX™ of Tektronix Inc. TOKO™ of TOKO KABUSHIKI KAISHA TA. UNIX™ of X/Open Company Limited. VERILOG™, PALLADIUM™ of Cadence Design Systems, Inc. VLYNQ™ of Texas Instruments Incorporated. VXWORKS™, WIND RIVER™ of WIND RIVER SYSTEMS, INC. ZETEX™ of Diodes Zetex Limited.

## Table of Contents

<b>1</b>	<b>Ordering and packaging information</b>	9
1.1	Pin description	9
<b>2</b>	<b>my-d™ Product Family</b>	10
2.1	my-d™ move and my-d™ move NFC	10
2.2	Application Segments	11
<b>3</b>	<b>Scope of my-d™ move / my-d™ move NFC</b>	12
3.1	Circuit Description	12
3.2	Memory Principle	13
3.2.1	Service Area 1	14
3.2.2	User Area 1	14
3.2.3	User Area 2	14
3.2.4	Service Area 2	14
3.3	Memory Principle for NFC Forum™ Type 2 Tag	15
3.4	System Overview	16
3.5	UID Coding	17
3.6	Supported Standards	17
3.7	Command Set	17
<b>4</b>	<b>Memory Organization</b>	18
4.1	User Memory Area 1 and 2	18
4.2	Service Area 1 and 2	19
4.2.1	Unique Identifier (UID)	19
4.2.2	Configuration Byte	20
4.2.2.1	Locking Mechanism for the Configuration Byte	20
4.2.3	Locking mechanism	21
4.2.4	OTP Block	22
4.2.5	Manufacturer Block (25H)	22
4.3	Memory Principle for NFC Forum™ Type 2 Tag	23
4.3.1	NFC Forum™ Static Memory Structure	23
4.3.2	NFC Forum™ Dynamic Memory Structure	24
4.4	Transport Configuration	26
4.4.1	Transport Configuration my-d™ move	26
4.4.2	Transport Configuration my-d™ move NFC	27
<b>5</b>	<b>Password</b>	29
5.1	Password Block	29
5.2	Password Retry Counter	29
5.3	Anti-tearing Mechanism for Password Retry Counter	31
<b>6</b>	<b>16-bit Value Counter Functionality</b>	32
6.1	Value Counter Format	32
6.2	Loading and Reading of Value Counter	33
6.3	Decrementing Value Counter and Anti-Tearing	34
6.4	Protection Mechanisms for the Value Counter	34
<b>7</b>	<b>Communication Principle</b>	35
7.1	Communication between a card (PICC) and a reader (PCD)	35
7.2	State Diagram	35
7.2.1	IDLE/HALT State	35
7.2.2	READY1/READY1* State	35

7.2.3	READY2/READY2* State	35
7.2.4	ACTIVE/ACTIVE* State	36
7.2.5	HALT State	36
7.3	Start up	37
7.3.1	Start-up sequence of the SLE 66R01P and SLE 66R01PN	37
7.4	Frame Delay Time	37
7.5	Error Handling	38
<b>8</b>	<b>Command Set</b>	<b>39</b>
8.1	Supported ISO/IEC 14443-3 Type A Command Set	39
8.2	Memory Access Command Set	39
8.2.1	Read 4 Blocks (RD4B)	41
8.2.2	Write 1 Block (WR1B)	42
8.2.3	Compatibility Write Command (CPTWR)	43
8.2.4	Read 2 Blocks (RD2B)	44
8.2.5	Write 2 Blocks (WR2B)	45
8.2.6	Set Password (SPWD)	46
8.2.7	Access (ACS)	47
8.2.8	Decrement Command (DCR16)	49
8.2.9	HLTA command	51
8.3	my-d™ move and my-d™ move NFC responses	52
8.3.1	Command responses	52
8.3.2	my-d™ move and my-d™ move NFC identification data	52
<b>9</b>	<b>Operational Characteristics</b>	<b>53</b>
9.1	Electrical Characteristics	53
9.2	Absolute Maximum Ratings	54

## List of Figures

Figure 1	Pin configuration die . . . . .	9
Figure 2	Block Diagram of the SLE 66R01P and SLE 66R01PN . . . . .	12
Figure 3	SLE 66R01P and SLE 66R01PN memory principle . . . . .	13
Figure 4	SLE 66R01P and SLE 66R01PN NFC Forum™ Type 2 Tag memory structure . . . . .	15
Figure 5	SLE 66R01P and SLE 66R01PN Contactless System Overview . . . . .	16
Figure 6	SLE 66R01P and SLE 66R01PN double-size UID . . . . .	17
Figure 7	my-d™ move and my-d™ move NFC memory organization . . . . .	18
Figure 8	Configuration Byte . . . . .	20
Figure 9	Locking and Block Locking Mechanism . . . . .	21
Figure 10	Static Memory Structure . . . . .	23
Figure 11	Generic NFC Forum™ Type 2 Tag dynamic memory layout (based on SLE 66R01P(N)) . . . . .	24
Figure 12	Example of a NFC Forum™ Type 2 Tag dynamic memory layout (based on SLE 66R01P(N)) . . . . .	25
Figure 13	my-d™ move Transport Configuration . . . . .	26
Figure 14	my-d™ move NFC Transport Configuration . . . . .	27
Figure 15	Password and Password Retry Counter configuration . . . . .	30
Figure 16	Value Counter - Principle . . . . .	32
Figure 17	Value Counter decrement example . . . . .	33
Figure 18	Start-up Sequence . . . . .	37
Figure 19	Read 4 Blocks Command . . . . .	41
Figure 20	Write 1 Block Command . . . . .	42
Figure 21	Compatibility Write Command . . . . .	43
Figure 22	Read 2 Blocks Command . . . . .	44
Figure 23	Write 2 Blocks Command . . . . .	45
Figure 24	Set Password Command . . . . .	46
Figure 25	Access Command . . . . .	47
Figure 26	Flow Diagram of the ACS Command . . . . .	48
Figure 27	Decrement Command . . . . .	49
Figure 28	Decrement Command flow . . . . .	50
Figure 29	HLTA Command . . . . .	51



## List of Tables

Table 1	Ordering information . . . . .	9
Table 2	Pin description and function . . . . .	9
Table 3	my-d™ family product overview . . . . .	11
Table 4	UID Coding . . . . .	17
Table 5	UID Description . . . . .	19
Table 6	Configuration Byte Definition . . . . .	20
Table 7	Example for OTP Block Lock and Block Lock . . . . .	22
Table 8	Writing to OTP Block (block 03H) from the user point of view . . . . .	22
Table 9	Capability Container settings for my-d™ move and my-d™ move NFC. . . . .	28
Table 10	Empty NDEF message . . . . .	28
Table 11	Access Rights . . . . .	29
Table 12	Behavior in case of an Error . . . . .	38
Table 13	ISO/IEC 14443-3 Type A Command Set . . . . .	39
Table 14	my-d™ move and my-d™ move NFC memory access command set . . . . .	39
Table 15	Read 4 Blocks (RD4B) . . . . .	41
Table 16	Write 1 Block (WR1B) . . . . .	42
Table 17	Compatibility Write (CPTWR) . . . . .	43
Table 18	Read 2 Block (RD2B) . . . . .	44
Table 19	Write 2 Block (WR2B) . . . . .	45
Table 20	Set Password (SPWD) . . . . .	46
Table 21	SPWD - behaviour in error case . . . . .	46
Table 22	Access (ACS) . . . . .	47
Table 23	ACS - behaviour in error case . . . . .	48
Table 24	Decrement (DCR16) . . . . .	49
Table 25	DCR16 - behaviour in error case . . . . .	50
Table 26	Halt (HLTA) . . . . .	51
Table 27	ACK and NACK as responses . . . . .	52
Table 28	Summary of SLE 66R01P and SLE 66R01PN identification data . . . . .	52
Table 29	Electrical Characteristics . . . . .	53
Table 30	Absolute Maximum Ratings . . . . .	54

## Features

### Intelligent 1216 bit EEPROM with Contactless Interface compliant to ISO/IEC 14443-3 Type A and support of NFC Forum™ Type 2 Tag Operation

#### Contactless Interface

- Physical Interface and Anticollision compliant to ISO/IEC 14443-3 Type A
  - Operation frequency 13.56 MHz
  - Data rate 106 kbit/s in both direction
  - Contactless transmission of data and supply energy
  - Anticollision logic: several cards may be operated in the field simultaneously
- Unique IDentification number (7-byte double-size UID) according to ISO/IEC 14443-3 Type A
- Read and Write Distance up to 10 cm and more (influenced by external circuitry i.e. reader and inlay design)

#### 152 byte EEPROM

- Organized in 38 blocks of 4 bytes each
- 128 bytes freely programmable User Memory
- 24 bytes of Service Area reserved for UID, Configuration, LOCK Bytes, OTP Block and Manufacturer Data
- Read and Write of 128 bytes of User Memory in less than 100 ms
- Programming time per block < 4 ms
- Endurance minimum 10,000 erase/write cycles<sup>1)</sup>
- Data Retention minimum 5 years<sup>1)</sup>

#### Privacy Features

- 32 bit of One Time Programmable (OTP) memory area
- Locking mechanism for each block
- Block Lock mechanism
- Optional 32 bit Password for Read/Write or Write access
- Optional Password Retry Counter
- Optional 16 bit Value Counter

#### Data Protection

- Data Integrity supported by 16 bit CRC, parity bit, command length check
- Anti-tearing mechanism for OTP, Password Retry Counter and Value Counter

#### NFC Forum™ Operation

- Compliant to NFC Forum™ Type 2 Tag Operation
- Support of Static and Dynamic Memory Structure according to NFC Forum™ Type 2 Tag Operation
- SLE 66R01PN: pre-configured NFC memory with empty NDEF message (INITIALIZED state, non-reversible)
- SLE 66R01P: UNINITIALIZED state, may be configured to INITIALIZED state

#### Electrical Characteristics

- On-Chip capacitance 17 pF ± 5%
- ESD protection minimum 2 kV
- Ambient Temperature -25°C ... +70°C (for the chip)

---

1) Values are temperature dependent



## 1 Ordering and packaging information

**Table 1 Ordering information**

Type	Package	Total Memory / User Memory <sup>1)</sup>	Ordering code
SLE 66R01P C	wafer sawn / unsawn	152 / 128 bytes	on request
SLE 66R01P NB	NiAu Bumped (sawn wafer)		SP000911428
SLE 66R01PN C	wafer sawn / unsawn		on request
SLE 66R01PN NB	NiAu Bumped (sawn wafer)		SP000953914

1) Total memory size includes the service area whereas user memory size is freely programmable for user data.

For more ordering information about the form of delivery please contact your local Infineon sales office.

### 1.1 Pin description

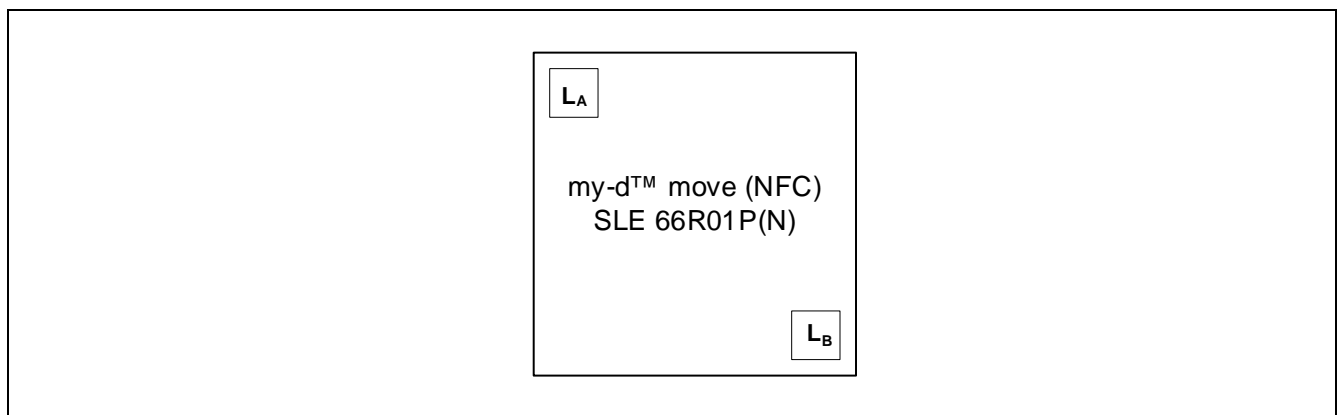

**Figure 1 Pin configuration die**

**Table 2 Pin description and function**

Symbol	Function
L <sub>A</sub>	Antenna Connection
L <sub>B</sub>	Antenna Connection

## **2 my-d™ Product Family**

my-d™ products are available both in plain mode with open memory access and in secure mode with memory access controlled by authentication procedures. The my-d™ product family provides users with different memory sizes, features NFC Forum™ Type 2 Tag functionality and incorporates security features to enable considerable flexibility in the application design.

Flexible controls within the my-d™ devices start with plain mode operation featuring individual page locking; for more complex applications various settings in secure mode can be set for multi user / multi application configurations.

In plain mode access to the memory is supported by both 4-byte block as well as 8-byte page structure.

In secure mode a cryptographic algorithm based on a 64-bit key is available. Mutual authentication, message authentication codes (MAC) and customized access conditions protect the memory against unauthorized access.

The functional architecture, meaning the memory organization and authentication of my-d™ products is the same for both my-d™ proximity (ISO/IEC 14443) and my-d™ vicinity (ISO/IEC 18000-3 mode 1 or ISO/IEC 15693). This eases the system design and allows simple adaptation between applications.

Configurable Value Counters featuring anti-tearing functionality are suitable for value token applications, such as limited use transportation tickets.

Architectural interoperability of my-d™ products enables an easy migration from simple to more demanding applications.

The my-d™ move family is designed for cost optimized applications and its implemented command set eases the usage in existing applications and infrastructures.

In addition, the my-d™ light (ISO/IEC 18000-3 mode 1 or ISO/IEC 15693) is part of the my-d™ family. Its optimized command set and memory expands the range of applications to cost sensitive segments.

### **2.1 my-d™ move and my-d™ move NFC**

The my-d™ move and my-d™ move NFC are part of Infineon's my-d™ product family and are designed to meet the requirements of the increasing NFC market demanding smart memories. They are compliant to ISO/IEC 14443-3 Type A, to ISO/IEC 18092 and to NFC Forum™ Type 2 Tag Operation.

128 Bytes of memory can be arranged in static or dynamic memory structures for NFC applications.

my-d™ move and my-d™ move NFC products also feature configurable Value Counters which support anti-tearing protection.

Privacy features like a password protection including password retry counter provide basic security to the applications.

Based on SLE 66R01P the SLE 66R01PN already contains a pre-configuration of the NFC memory indicating the INITIALIZED state according to the definition of the NFC Forum™ Type 2 Tag life cycle. Due to that the my-d™ move NFC is ready to be used in NFC infrastructures.

my-d™ move and my-d™ move NFC products are suited for a broad range of applications like public transport, event ticketing or smart posters.

## 2.2 Application Segments

my-d™ products are optimized for personal and object identification. Please find in the following table some dedicated examples

**Table 3 my-d™ family product overview**

Product	Application
my-d™ move - SLE 66R01P	Public Transport, Smart Posters, NFC Device Pairing
my-d™ move NFC - SLE 66R01PN	Public Transport, Smart Posters, NFC Device Pairing, NFC INITIALIZED state
my-d™ move lean - SLE 66R01L	Public Transport, Smart Posters, NFC Device Pairing
my-d™ NFC - SLE 66RxxP	Smart Posters and Maps, NFC Device Pairing, Loyalty Schemes, Consumer Good Information, Healthcare Monitoring
my-d™ proximity 2 - SLE 66RxxS	Access Control, Entertainment, Public Transport, Customer Loyalty Schemes, Micro Payment
my-d™ proximity enhanced - SLE 55RxxE	Access Control, Gaming, Entertainment, Customer Loyalty Schemes
my-d™ light - SRF 55V01P	Libraries, Laundry, Factory Automation, Media Management, Event Ticketing, Leisure Park Access
my-d™ vicinity plain - SRF 55VxxP	Factory Automation, Healthcare, Ticketing, Access Control
my-d™ vicinity plain HC - SRF 55VxxP HC	Ticketing, Brand Protection, Loyalty Schemes, Ski passes
my-d™ vicinity secure - SRF 55VxxS	Ticketing, Brand protection, Loyalty Schemes, Access Control

### 3 Scope of my-d™ move / my-d™ move NFC

The SLE 66R01P and SLE 66R01PN are part of the Infineon my-d™ product family and support Infineon's transport and ticketing strategy and are designed to meet the requirements of NFC applications.

They are compliant to ISO/IEC 14443-3 Type A, to ISO/IEC 18092 and to NFC Forum™ Type 2 Tag Operation.

#### 3.1 Circuit Description

The SLE 66R01P and SLE 66R01PN are made up of an EEPROM memory unit, an analog interface for contactless operation, a data transmission path and a control unit. The following diagram shows the main blocks of the SLE 66R01P and SLE 66R01PN.

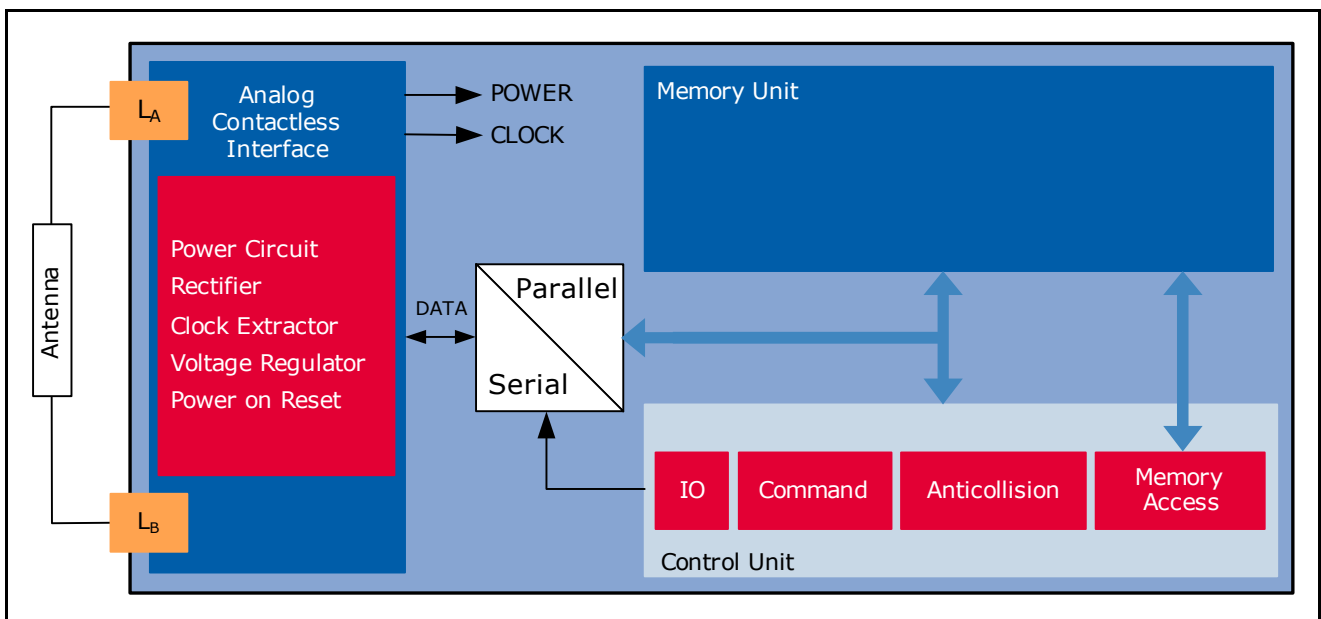

Figure 2 Block Diagram of the SLE 66R01P and SLE 66R01PN

The SLE 66R01P and SLE 66R01PN comprise the following three parts:

- **Analog Contactless Interface**
  - The Analog Contactless Interface contains the voltage rectifier, voltage regulator and system clock to supply the IC with appropriate power. Additionally the data stream is modulated and demodulated.
- **Memory Unit**
  - The Memory Unit consists of 38 blocks of 4 bytes each.
- **Control Unit**
  - The Control Unit decodes and executes all commands. Additionally the control unit is responsible for the correct anticollision flow.

### 3.2 Memory Principle

The total amount of addressable memory is 152 bytes organized in blocks of 4 bytes each.

The general structure comprises Service Areas as well as User Areas:

- 24 bytes of service and administration data (located in Service Area 1 and 2) reserved for
  - 7-byte double-size UID
  - configuration data
  - LOCKx bytes
  - OTP memory
  - Manufacturing Data
- 128 bytes of User memory (located in User Area 1 and 2) reserved for
  - User Data
  - Value Counter

Additionally the Password and Password Retry Counter are available and accessible via dedicated commands.

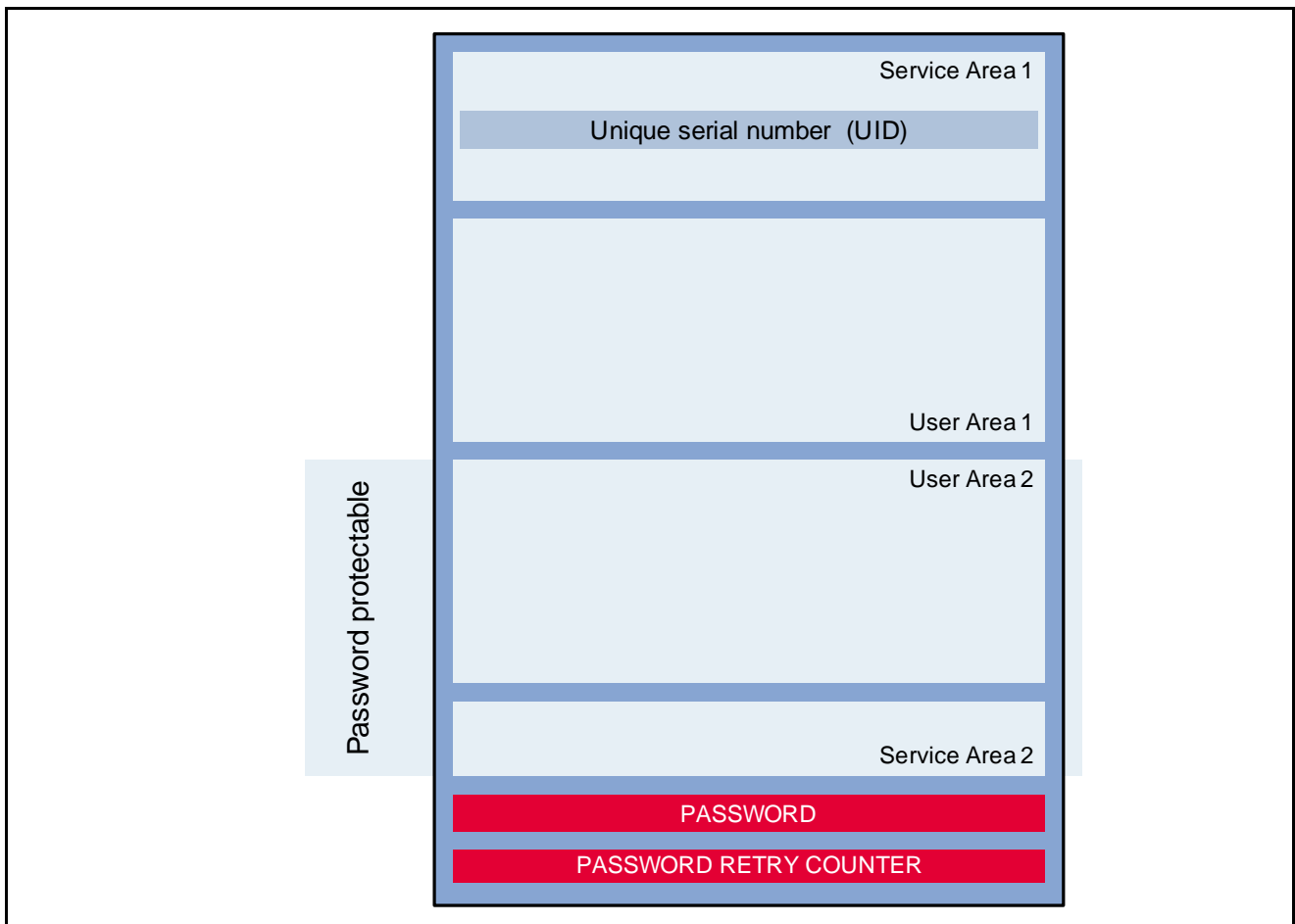

Figure 3 SLE 66R01P and SLE 66R01PN memory principle

### 3.2.1 Service Area 1

Service Area 1 contains

- the 7-byte UID which is programmed at manufacturing of the chip and cannot be changed
- CONFIG byte to enable the Password (incl. the Password Retry counter) and the Value Counter functionality
- LOCK0, LOCK1 bytes to enable an irreversible write-protection for the blocks located in User Area 1
- 32 bits of the One-Time-Programmable (OTP) memory block can irreversibly be programmed from 0<sub>B</sub> to 1<sub>B</sub>

### 3.2.2 User Area 1

48 bytes (12 blocks, 4 bytes each) of memory for user data.

### 3.2.3 User Area 2

User Area 2 contains

- 80 bytes (20 blocks, 4 bytes each) of user memory for user data. These memory blocks can be used to store user data. This portion of the memory may be protected with a 32 bit password.
- a 16-bit Value Counter may be activated providing a mechanism to store some value (points, trips, ...) on the my-d™ move and my-d™ move NFC chip.

### 3.2.4 Service Area 2

Service Area 2 contains

- lock bytes LOCK2 to LOCK5 to enable an irreversible write-protection for the blocks located in User Area 2
- Manufacturing Data (programmed during manufacturing of the chip) which cannot be changed



### 3.3 Memory Principle for NFC Forum™ Type 2 Tag

The memory organization is configurable according to the NFC Forum™ Type 2 Tag Operation specification. Static or dynamic memory structures are supported.

**Figure 4** illustrates the principle of the SLE 66R01P and SLE 66R01PN as a NFC Forum™ Type 2 Tag compatible chip. The memory can be accessed with NFC Forum™ Type 2 Tag commands.

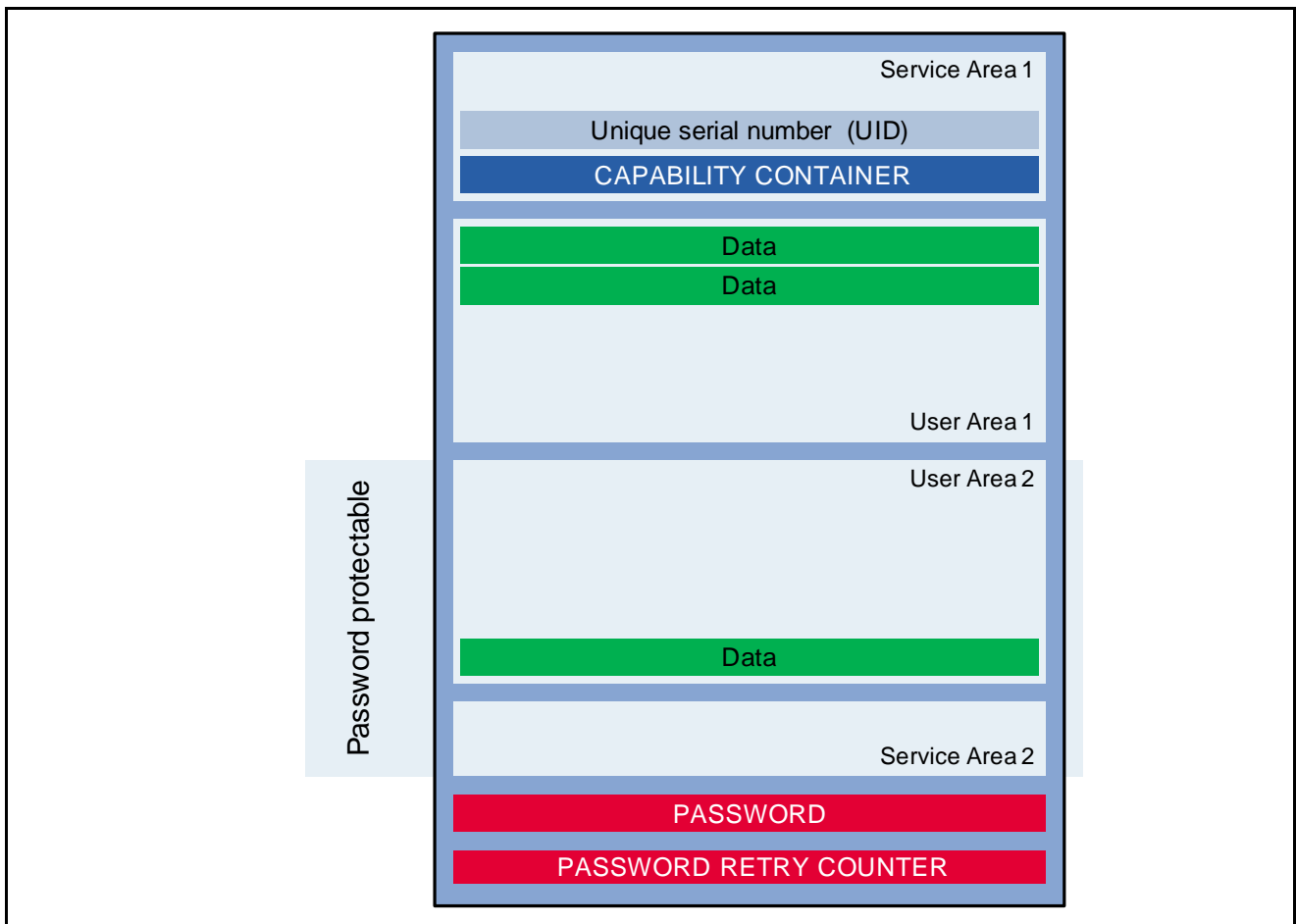

**Figure 4 SLE 66R01P and SLE 66R01PN NFC Forum™ Type 2 Tag memory structure**

Based on SLE 66R01P the SLE 66R01PN already contains a pre-configuration of the NFC memory indicating the INITIALIZED state according to the definition of the NFC Forum™ Type 2 Tag life cycle. With this pre-configuration the my-d™ move NFC can be immediately used in NFC infrastructures.

For details regarding the NFC initialization of my-d™ move and my-d™ move NFC please refer the the Application Note “How to operate my-d™ move and my-d™ move NFC devices in NFC Forum™ Type 2 Tag infrastructures” available at Chip Card & Security [security.chipcard.ics@infineon.com](mailto:security.chipcard.ics@infineon.com).

**Attention: The pre-configuration of SLE 66R01PN is nonreversible and the my-d™ move NFC cannot be overwritten and used as plain, standard my-d™ move anymore.**

### 3.4 System Overview

The system consists of a host system, one or more SLE 66R01P / SLE 66R01PN tags or other ISO/IEC 14443-3 Type A compliant cards and an ISO/IEC 14443-3 Type A compatible contactless reader.

Alternatively, since the SLE 66R01P and SLE 66R01PN can be used in NFC Forum™ Type 2 Tag memory structures, a NFC Forum™ device in card reader/writer mode can be used to operate the chip.

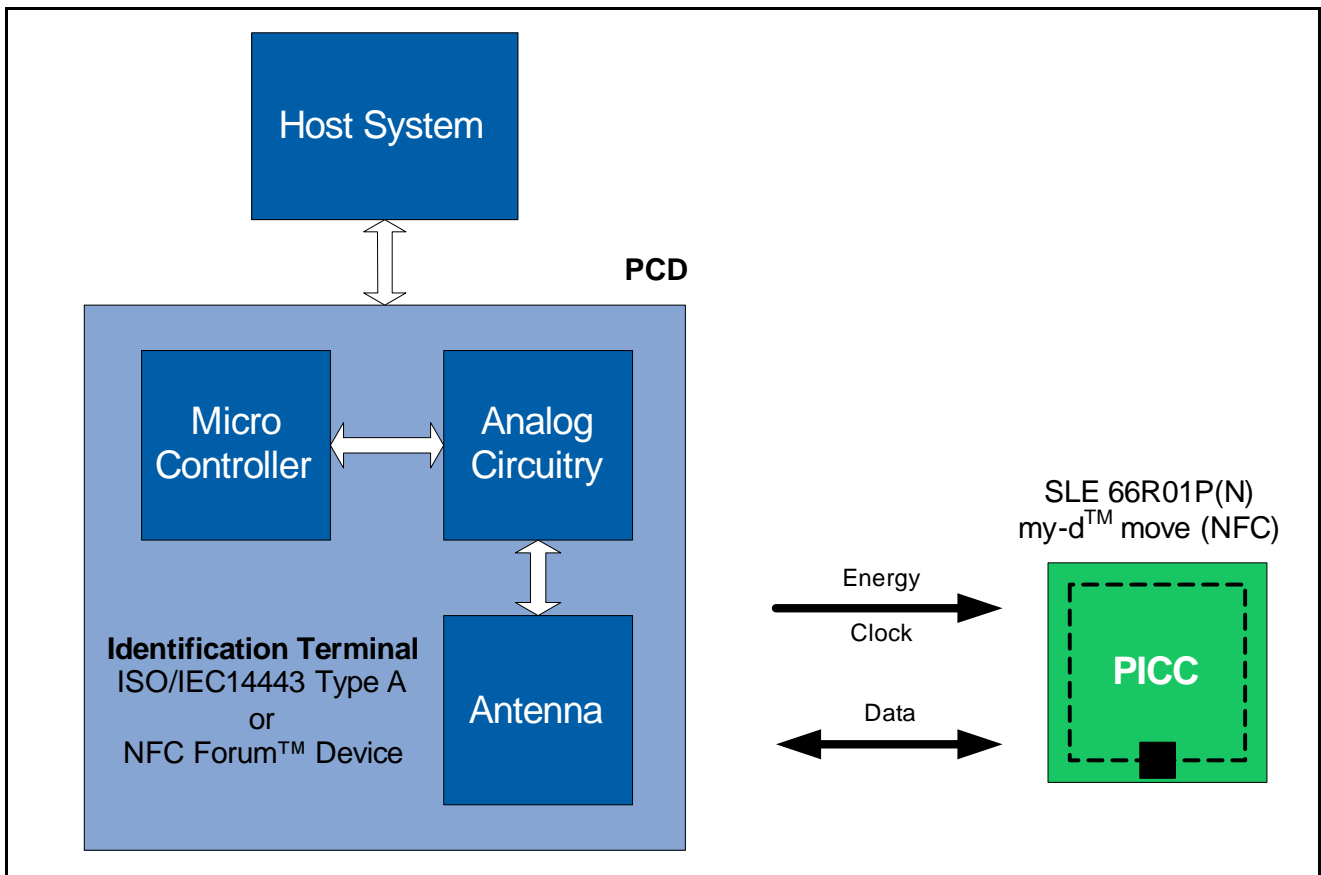

Figure 5 SLE 66R01P and SLE 66R01PN Contactless System Overview

### 3.5 UID Coding

To identify a SLE 66R01P and SLE 66R01PN chip the manufacturer code and a chip family identifier are coded into the UID as described in the [Table 4](#). The chip family identifier can be used to determine the basic command set for the chip.

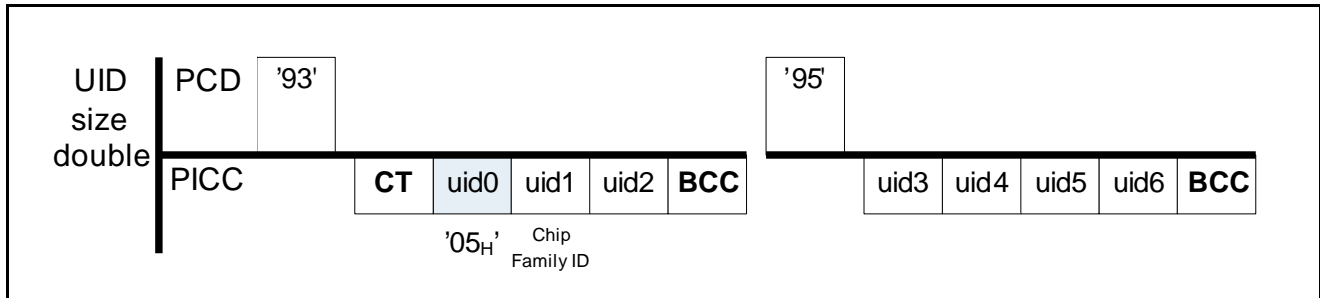

Figure 6 SLE 66R01P and SLE 66R01PN double-size UID

Table 4 UID Coding

UID Field	Value	Description
uid0	05 <sub>H</sub>	IC Manufacturer Code according to ISO/IEC 7816-6
uid1	3x <sub>H</sub>	Chip Family Identifier Higher Nibble: 0011 <sub>B</sub> : my-d™ move and my-d™ move NFC Lower Nibble: part of the UID number

### 3.6 Supported Standards

the SLE 66R01P and SLE 66R01PN support the following standards:

- ISO/IEC 14443 Type A (Parts 1, 2 and 3)  
tested according to ISO/IEC 10373-6 (PICC Test & Validation)
- ISO/IEC 14443-3 Type A
- NFC Forum™ Type 2 Tag Operation

### 3.7 Command Set

The SLE 66R01P and SLE 66R01PN is compliant to the ISO/IEC 14443-3 Type A standard.

A set of standard ISO/IEC 14443-3 Type A commands is implemented to operate the chip.

Additionally NFC Forum™ Type 2 Tag commands and a my-d™ move and my-d™ move NFC specific command set is implemented. This facilitates the access to the on-chip integrated memory and supports the execution of password and counter functionality.

## 4 Memory Organization

The total amount of user memory is 152 byte. It is organized in blocks of 4 bytes each.

It comprises:

- 128 bytes for user data
- 24 bytes for UID, OTP, locking information, IC configuration and manufacturer information.

Additionally the Password and Password Retry Counter are allocated in non-addressable part of the memory and are accessible via dedicated commands only.

Figure 7 shows the memory structure of the SLE 66R01P and SLE 66R01PN chip.

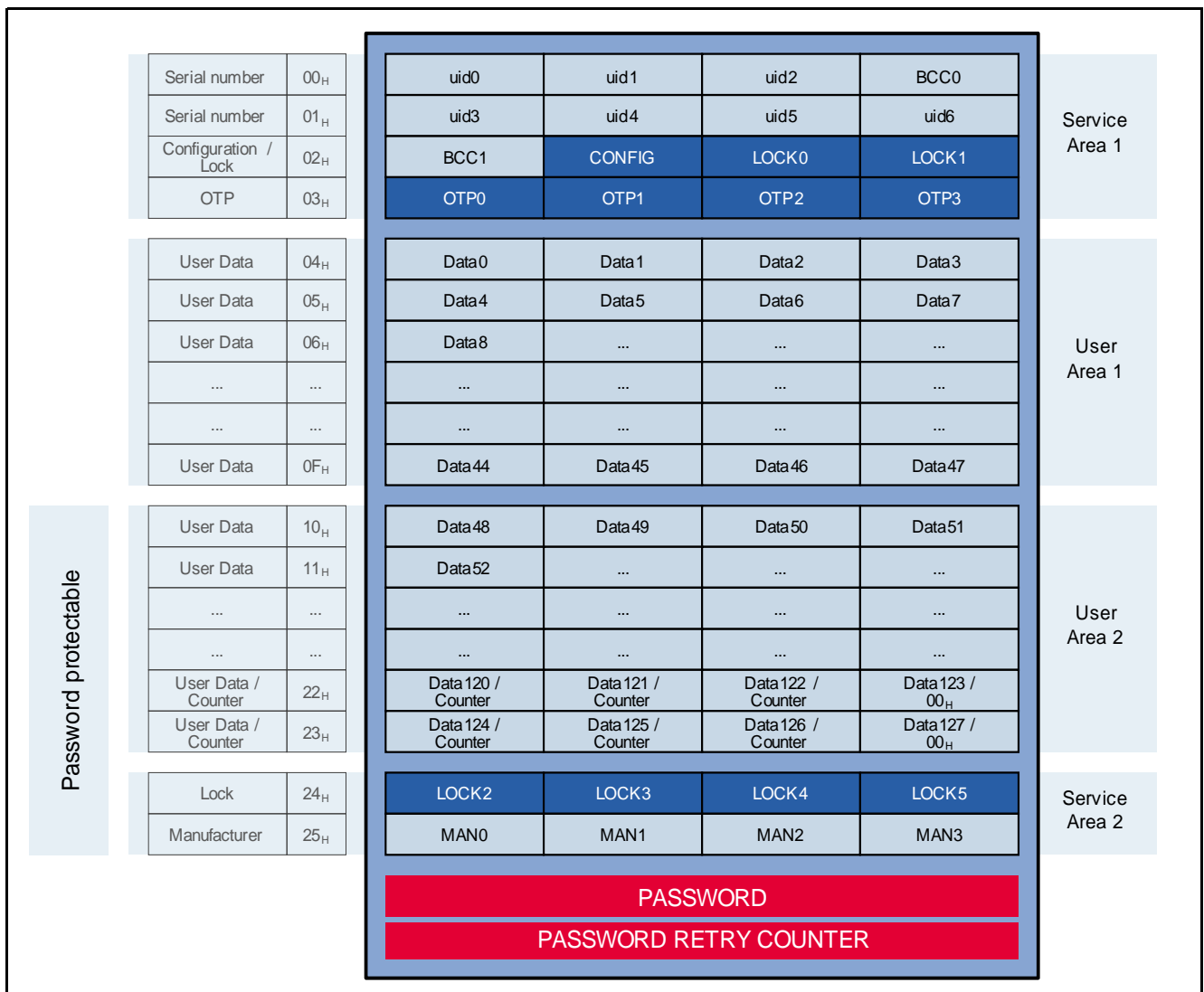

Figure 7 my-d™ move and my-d™ move NFC memory organization

### 4.1 User Memory Area 1 and 2

Blocks from address 04<sub>H</sub> to 23<sub>H</sub> belong to the User Memory Area (1 and 2). This part of the memory is readable / writable as well as lockable against unintentional overwriting using a locking mechanism.

Moreover the User Memory Area 2 above the address 10<sub>H</sub> can be protected with a Password against unintentional reading or reading/writing.

## 4.2 Service Area 1 and 2

The Service Area 1 (block address 00<sub>H</sub> to 03<sub>H</sub>) contains

- 7-byte double-size UID (plus two bytes of UID BCC information)
- Configuration Byte
- LOCK0 and LOCK1 to lock the OTP block and blocks in User Area 1
- 32 bit OTP memory

The Service Area 2 (block address 24<sub>H</sub> to 25<sub>H</sub>) contains

- LOCK2 - LOCK5 to lock blocks in User Area 2
- Manufacturer Data

### 4.2.1 Unique Identifier (UID)

The 9 bytes of the UID (7 byte UID + 2 bytes BCC information) are allocated in Block 00<sub>H</sub>, Block 01<sub>H</sub> and Byte 1 of Block 02<sub>H</sub> of the my-d™ move and my-d™ move NFC memory. All bytes are programmed and locked during the manufacturing process. These bytes cannot be changed.

For the content of the UID the following definitions apply:

- SLE 66R01P and SLE 66R01PN support Cascade Level 2 UID according to the ISO/IEC 14443-3 Type A which is a 7 byte unique number

The table below describes the content of the UID including the BCC information.

**Table 5 UID Description**

Cascade Level 2 - double-size UID										
UID Byte	CT <sup>1)</sup>	uid0 <sup>2)</sup>	uid1 <sup>3)</sup>	uid2	BCC0 <sup>4)</sup>	uid3	uid4	uid5	uid6	BCC1 <sup>4)</sup>
1)	CT is the Cascade Tag and designates CL2. It has a value of 88 <sub>H</sub> . Please note that CT is hardwired and not stored in the memory.									
2)	uid0 is the Manufacturer Code: 05 <sub>H</sub> according to ISO/IEC 7816-6									
3)	uid1 is the Chip Family Identifier. The higher significant nibble identifies a my-d™ move and my-d™ move NFC chip (0011 <sub>B</sub> ). The lower significant nibble of uid1 is part of the serial number.									
4)	BCCx are the UID CLn checkbytes calculated as Exclusive-OR over the four previous bytes (as described in ISO/IEC 14443-3 Type A). BCCx is stored in the memory and read-out during the anti-collision.									

## 4.2.2 Configuration Byte

The Configuration Byte defines the configurable functionality of the my-d™ move and my-d™ move NFC. It is allocated in Byte 1 of Block 02<sub>H</sub>. At delivery all bits of the Configuration Byte are set to 0<sub>B</sub>. Note that the Configuration Byte is One Time Programmable (OTP) byte. Bits allocated in this byte can only be logically set to 1<sub>B</sub>, which is an irreversible process i.e. bits can not be reset to 0<sub>B</sub> afterwards.

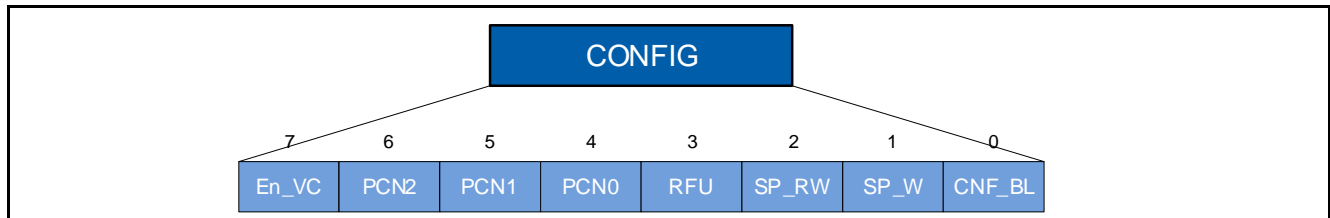

Figure 8 Configuration Byte

Table 6 Configuration Byte Definition

Configuration Bit	Abbreviation	Description
Configuration Byte Lock	CNF_BL	0 <sub>B</sub> ... Configuration Byte programmable 1 <sub>B</sub> ... Configuration Byte locked
Set Password for Write access	SP-W	0 <sub>B</sub> ... The Write Password is not active 1 <sub>B</sub> ... The Write Password is active for Write Commands which are applied to all blocks starting from the address 10 <sub>H</sub>
Set Password for Read and Write access	SP_WR	0 <sub>B</sub> ... The Read and Write Password is not active 1 <sub>B</sub> ... The Read and Write Password is active for read, write and decrement commands for all blocks above address 0F <sub>H</sub>
RFU	RFU	Reserved for the future use
Initial value of the Password Retry Counter	PCN2 PCN1 PCN0	000 <sub>B</sub> ... Default setting 111 <sub>B</sub> ... Maximal initial value (7 <sub>D</sub> ) Password Retry Counter is only active if the initial value is different than 0 <sub>D</sub> .
16-bit Value Counter	En_VC	0 <sub>B</sub> ... Value Counter is not configured, blocks 22 <sub>H</sub> and 23 <sub>H</sub> are User Data blocks 1 <sub>B</sub> ... Value Counter is set, blocks 22 <sub>H</sub> and 23 <sub>H</sub> are reserved for the 16-bit Value Counter

*Note: The CNF\_BL bit is active immediately after writing. To activate the new configuration of SP-W, SP-WR and VCRN16 bits the execution of REQA or WUPA commands is required. The new value of the Password Retry Counter (PCN2, PCN1 and PCN0 bits) is active immediately, i.e. is read each time the information is required (during the execution of the Access command).*

### 4.2.2.1 Locking Mechanism for the Configuration Byte

The my-d™ move and my-d™ move NFC is delivered with all bits of Configuration Byte set to 0<sub>B</sub>. The issuer should define the functionality of a chip as required (set e.g. Write and/or Read/Write Password, the Password Retry Counter, the 16-bit Value Counter etc.) and lock the Configuration Byte. Once the Configuration Byte is locked no further changes to the Configuration Byte are possible.

*Note: If all three BL Bits in the LOCK0 Byte are set to 1<sub>B</sub>, block 02<sub>H</sub> is locked. It is then not possible to change the value of this particular block (02<sub>H</sub>) any more.*



### 4.2.3 Locking mechanism

Bytes LOCK0, LOCK1 allocated in Block 02<sub>H</sub> and LOCK2, LOCK3, LOCK4 and LOCK5 allocated in Block 24<sub>H</sub> represent the one time field programmable bits which are used to lock the blocks in the specified address range from block 03<sub>H</sub> (OTP Block) to 23<sub>H</sub>.

Each block in this range can be individually locked to prevent further write access. A locking mechanism of each block is irreversible, i.e. once the locking information of a particular block (Lx) is set to 1<sub>B</sub> it can not be reset back to 0<sub>B</sub> any more. **Figure 9** illustrates the locking bytes with the corresponding locking bits.

Furthermore, it is possible to freeze the locking information of some memory areas by setting Block Locking (BL) bits e.g. if the bit BL 15-10 is set to 1<sub>B</sub> then the locking information for the corresponding area (L10 to L15) is not changeable any more. See the example in the **Table 7** below.

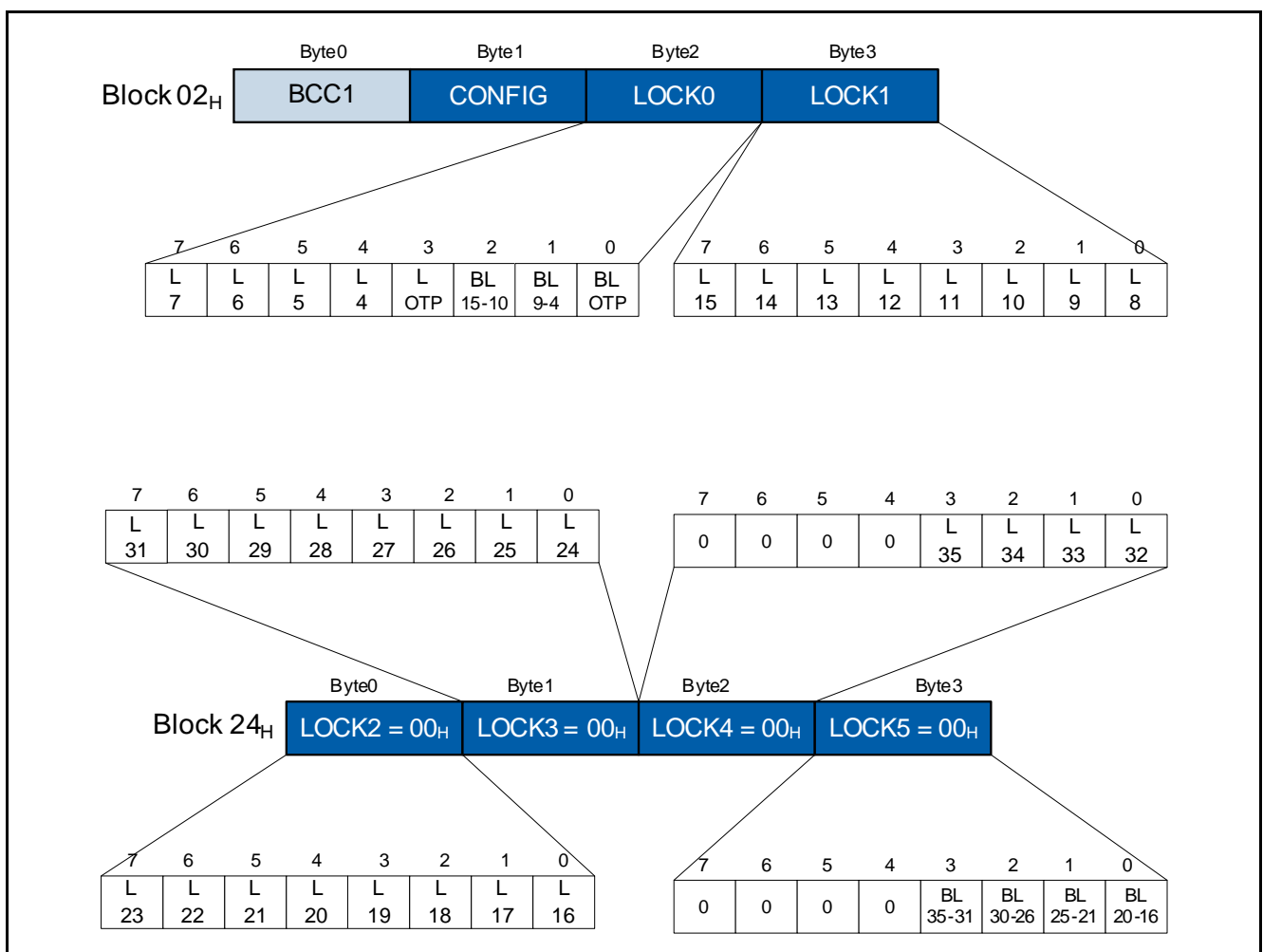

**Figure 9 Locking and Block Locking Mechanism**

The Write One Block (WR1B) command should be used to set the locking or block locking information of a certain block.

If WR1B is applied to Block 02<sub>H</sub> then:

- the Byte 0 (BCC1) will not be changed
- the Byte 1 (Configuration Byte) will be changed only if it is not locked

If WR1B is applied to Block 24<sub>H</sub> then:

- the Byte2 [7..4] = Lock4[7..4] and
- the Byte3 [7..4] = Lock5[7..4] will not be changed neither.

The locking and block locking for a certain block is active immediately after writing. That means that it is not necessary to execute the REQA or WUPA command in order to activate the locking.

*Note: If all three BL bits in the LOCK0 byte are set to 1<sub>B</sub> then Block 02<sub>H</sub> is locked. It is not possible to change the locking bits of this block any more. The same applies for block 24<sub>H</sub>. If BL bits of the LOCK5 byte are set to 1<sub>B</sub> then this block is locked. In this case the SLE 66R01P and SLE 66R01PN responds with NACK to a corresponding Write command.*

**Table 7 Example for OTP Block Lock and Block Lock**

BL OTP	L OTP	OTP BLOCK STATE
0 <sub>B</sub>	0 <sub>B</sub>	OTP Block Unlocked
0 <sub>B</sub>	1 <sub>B</sub>	OTP Block Locked
1 <sub>B</sub>	0 <sub>B</sub>	OTP Block Unlocked and can not be locked ever more
1 <sub>B</sub>	1 <sub>B</sub>	OTP Block Locked

An Anti-Tearing mechanism is implemented for Lock bytes on the SLE 66R01P and SLE 66R01PN. This mechanism prevents a stored value to be lost in case of a tearing event. This increases the level of data integrity and it is transparent to the customer.

#### 4.2.4 OTP Block

The Block 03<sub>H</sub> is a One Time Programmable (OTP) Block. Bits allocated in this block can only be logically set to 1<sub>B</sub>, which is an irreversible process i.e. bits can not be reset to 0<sub>B</sub> afterwards.

The Write One Block (WR1B) command should be used to program a specific OTP value. Incoming data of the WR1B command are bit-wise OR-ed with the current content of the OTP Block and the result is written back to the OTP Block.

**Table 8 Writing to OTP Block (block 03<sub>H</sub>) from the user point of view**

OTP Block	Representation bit-wise	Description
Initial value	0000 0000 0000 0000 0000 0000 0000 0000 <sub>B</sub>	Production setting
Write [55550003] <sub>H</sub>	0101 0101 0101 0101 0000 0000 0000 0011 <sub>B</sub>	Bit-wise "OR" with previous content of block 03 <sub>H</sub>
Write [AA55001C] <sub>H</sub>	1111 1111 0101 0101 0000 0000 0001 1111 <sub>B</sub>	Bit-wise "OR" with previous content of block 03 <sub>H</sub>

An Anti-Tearing mechanism is implemented for the OTP Block on the my-d™ move and my-d™ move NFC. This mechanism prevents the stored value to be lost in case of a tearing event. This increases the level of data integrity and is transparent to the customer.

#### 4.2.5 Manufacturer Block (25<sub>H</sub>)

The Manufacturer Block is used to store the my-d™ move and my-d™ move NFC internal on-chip configuration data and the manufacturing data such as Week and Year of production, Lot and Wafer Counter etc. This block is programmed and locked at manufacturing.

### 4.3 Memory Principle for NFC Forum™ Type 2 Tag

This section describes how to map the my-d™ move and my-d™ move NFC memory into the memory structures defined in the NFC Forum™ Type 2 Tag technical specification. This enables the usage of the my-d™ move and my-d™ move NFC as a NFC Forum™ Type 2 Tag compatible chip.

#### 4.3.1 NFC Forum™ Static Memory Structure

The Static Memory Structure is applied to a NFC Forum™ Type 2 Tag with a memory size equal to 64 bytes (see [Figure 10](#)). Blocks 04<sub>H</sub> to 0F<sub>H</sub> are available to store user data.

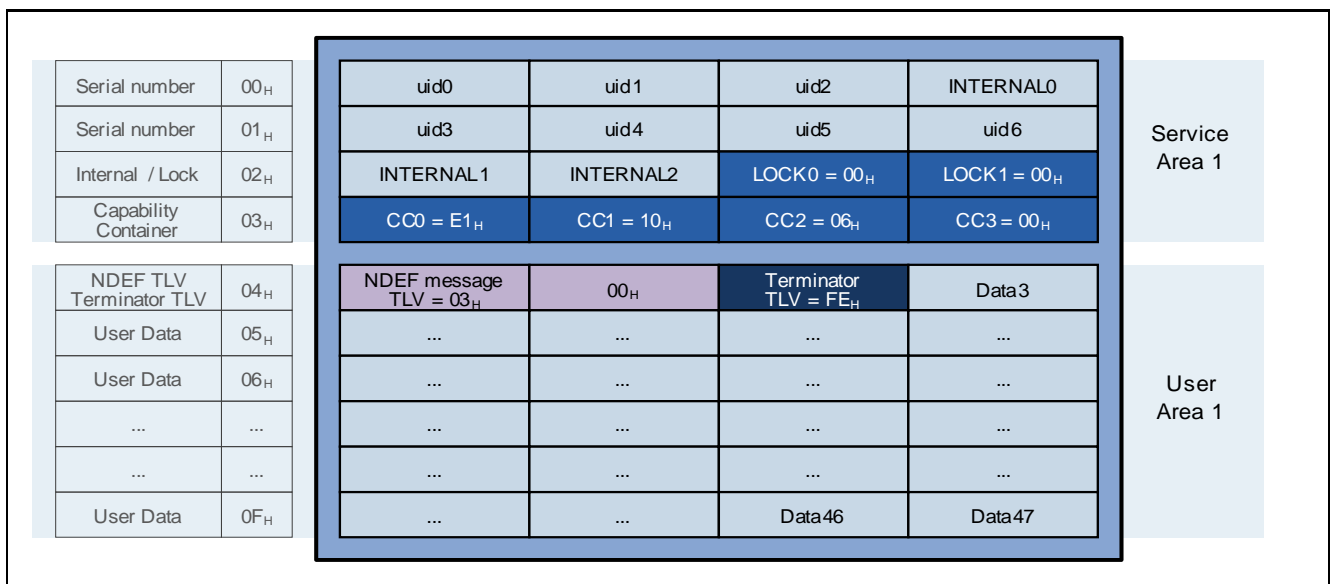
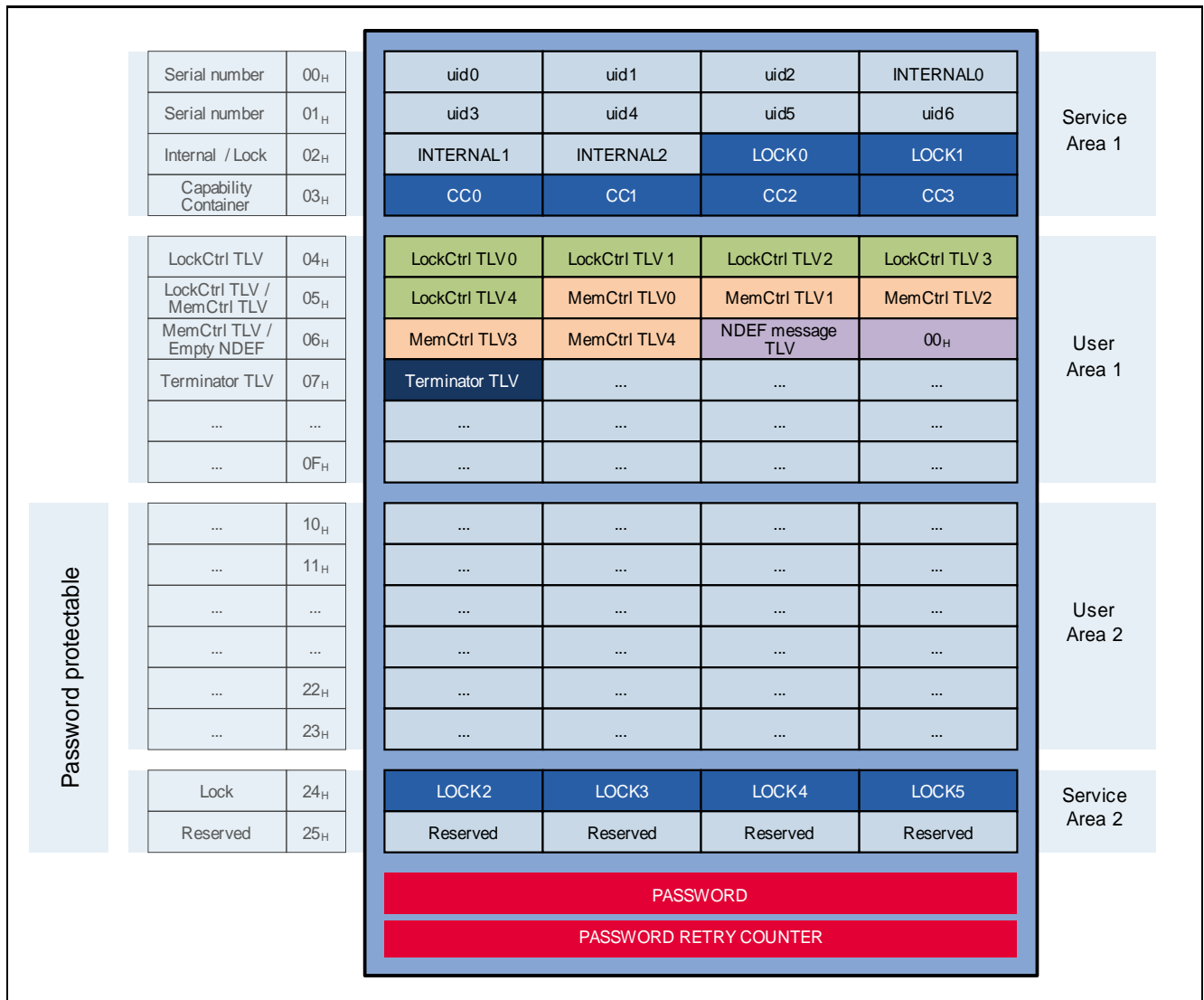

**Figure 10 Static Memory Structure**

The Static Memory Structure is characterized by the NDEF message TLV (03<sub>H</sub>) starting at block address 04<sub>H</sub>. The NFC data shown in [Figure 10](#) is an empty NDEF message (see [Table 10](#)).

### 4.3.2 NFC Forum™ Dynamic Memory Structure

The Dynamic Memory Structure can be applied to NFC Forum™ Type 2 Tags with bigger memories than 64 bytes. **Figure 11** shows a generic memory layout with a Dynamic Memory Structure (based on the my-d™ move and my-d™ move NFC chip).

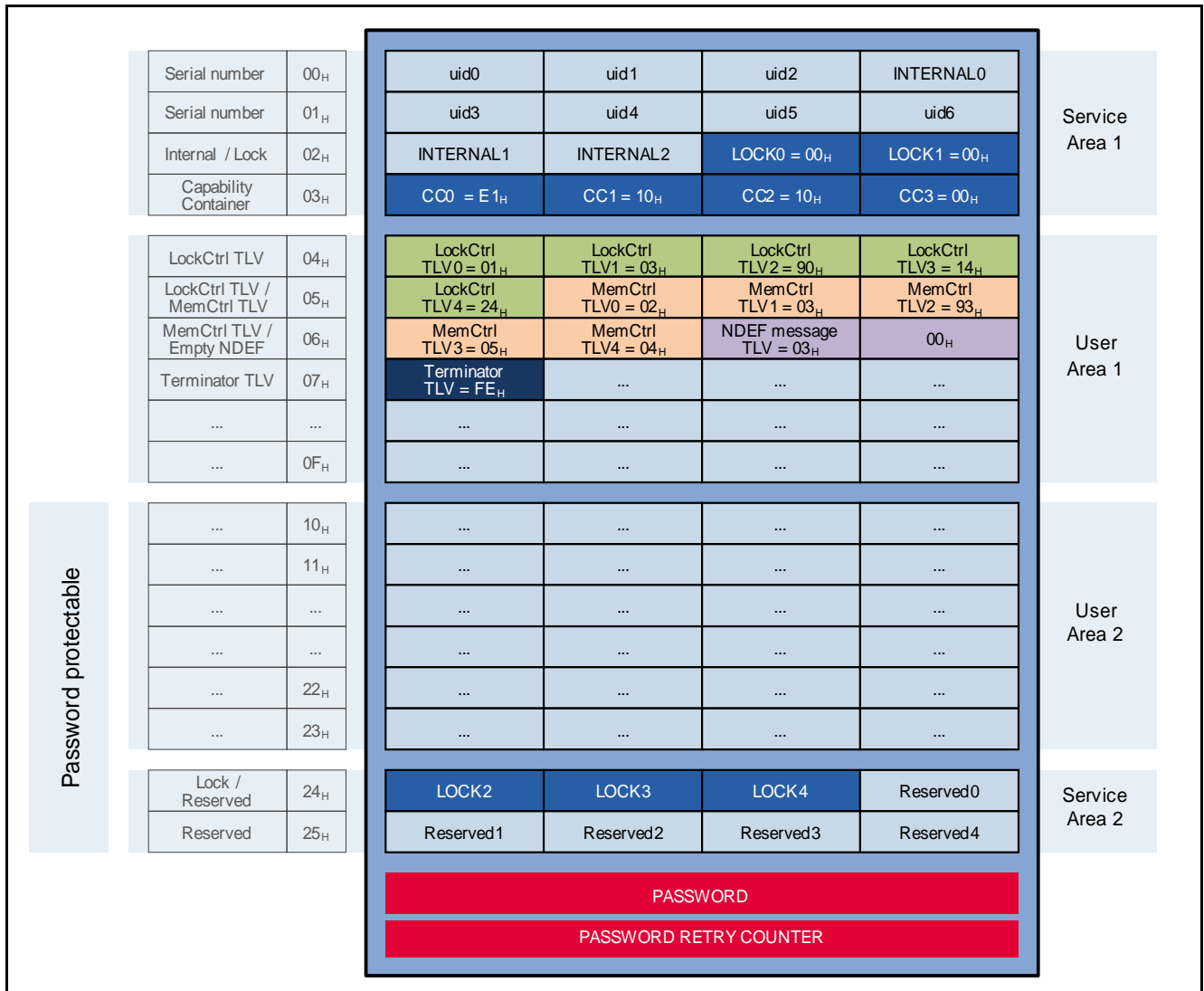

**Figure 11 Generic NFC Forum™ Type 2 Tag dynamic memory layout (based on SLE 66R01P(N))**

Compared to the Static Memory Structure the Dynamic Memory Structure is characterized by the NDEF message TLV starting after the Lock Control TLV and Memory Control TLV (the Lock Control TLV starts at Block 04<sub>H</sub>).

Within a Dynamic Memory Structure dynamic lock bytes and reserved bytes might be located at any address in the data area (see LOCK2 - LOCK5, Reserved shown in **Figure 11**). The location and the number of bytes used for these purposes is defined by the settings of the Lock Control TLV respectively Memory Control TLV.

Following example for a Dynamic Memory Structure (shown in **Figure 12**) focusses on my-d™ move and my-d™ move NFC.



**Figure 12 Example of a NFC Forum™ Type 2 Tag dynamic memory layout (based on SLE 66R01P(N))**

If a NFC Forum™ Type 2 Tag compliant chip with Lock Control TLV and Memory Control TLV is required, NFC Forum™ Type 2 Tag specific data such as Capability Container, Lock Control TLV, Memory Control TLV, NDEF Message and Terminator TLV should be written to the memory according to the given hardware configuration.

**Figure 12** holds valid Lock Control TLV and the Memory Control TLV settings within a Dynamic Memory Structure specially suited for the my-d™ move and my-d™ move NFC devices. For my-d™ move and my-d™ move NFC the position of the static and dynamic lock bytes is hard-wired and it is not possible to change their position in the memory.

- Static lock bytes LOCK0 and LOCK1 are allocated in block 2, bytes 2 and 3. LOCK0 and LOCK1 are used to lock blocks from address 00<sub>H</sub> to 0F<sub>H</sub>.
- Dynamic lock bytes LOCK2 to LOCK5 are allocated in block 24<sub>H</sub>. These LOCKx bytes are used to lock blocks starting from address 10<sub>H</sub>. The position and the number of dynamic lock bits is coded into the Lock Control TLV as shown above. In this example 20 lock bits are required to lock the User Memory blocks 10<sub>H</sub> to 23<sub>H</sub>. Furthermore the Memory Control TLV defines the location and number of reserved bytes in the memory.

## 4.4 Transport Configuration

Figure 11 shows the memory principle of SLE 66R01P and SLE 66R01PN. Following sections provide details about the initial memory content of these devices.

### 4.4.1 Transport Configuration my-d™ move

The transport configuration of SLE 66R01P contains following information:

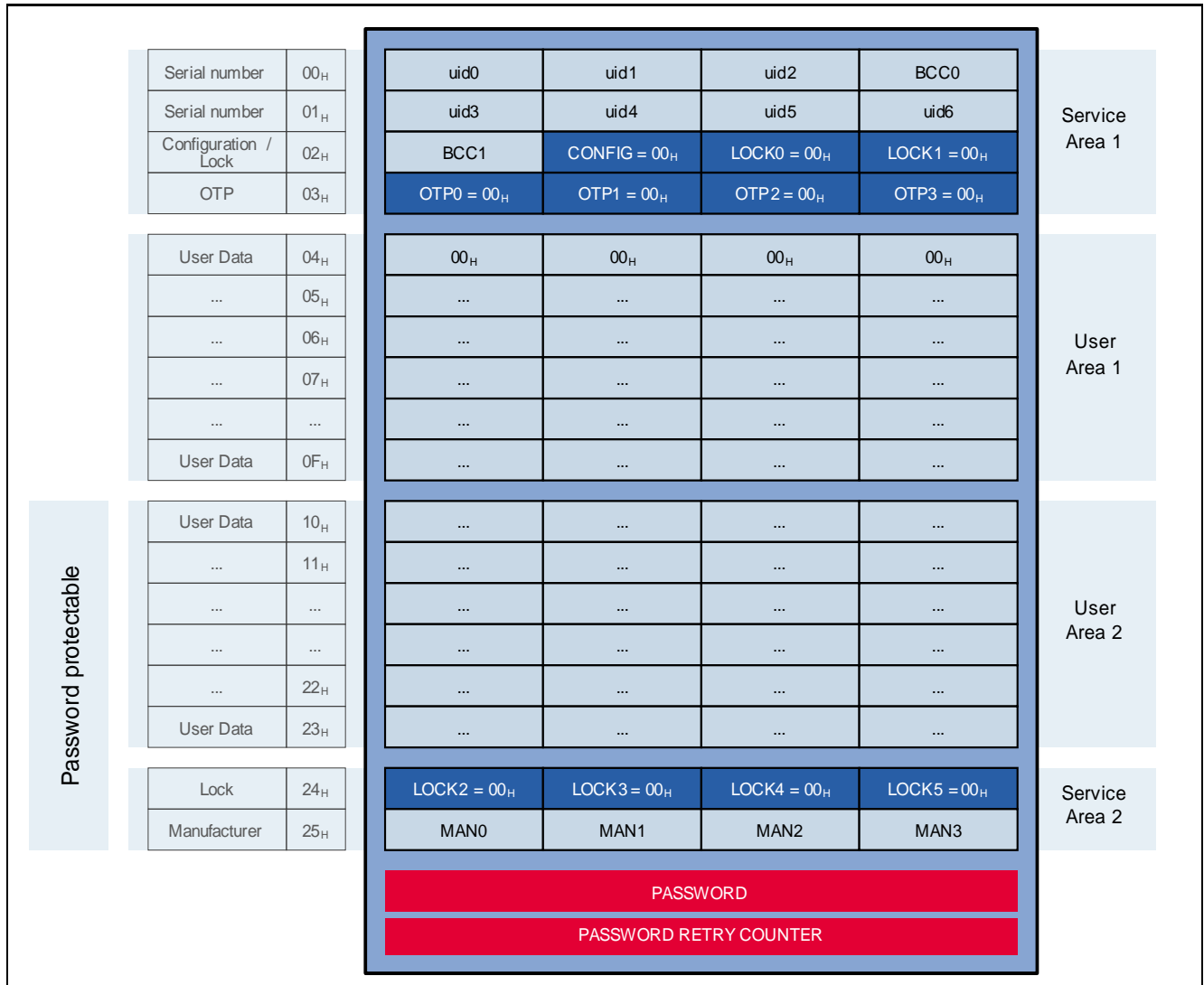

Figure 13 my-d™ move Transport Configuration

- Service Area 1 contains
  - predefined UID (incl. BCC bytes); read-only
  - CONFIG, LOCK0, LOCK1 set to 00<sub>H</sub>
  - LOCK0, LOCK1 set to 00<sub>H</sub>
  - OTP0 - OTP3 set to 00<sub>H</sub>
- User Area 1
  - all Data bytes set to 00<sub>H</sub>
- User Area 2
  - all Data bytes set to 00<sub>H</sub>
- Service Area 2 contains



- LOCK2 - LOCK5 set to 00<sub>H</sub>
- Manufacturer Data; read-only
- Password set to 00<sub>H</sub> 00<sub>H</sub> 00<sub>H</sub> 00<sub>H</sub>
- Password Retry Counter
  - deactivated by the setting of the CONFIG byte

The SLE 66R01P may be configured to INITIALIZED state according to the definition to the NFC Forum™ Type 2 Tag life cycle by writing

- Capability Container bytes (see [Table 9](#)) to Block 03<sub>H</sub>
- empty NDEF message TLV incl. Terminator TLV (see [Table 10](#)) to Block 04<sub>H</sub>

#### 4.4.2 Transport Configuration my-d™ move NFC

SLE 66R01PN is delivered in INITIALIZED state (life cycle) according to the NFC Forum™ Type 2 Tag specification.

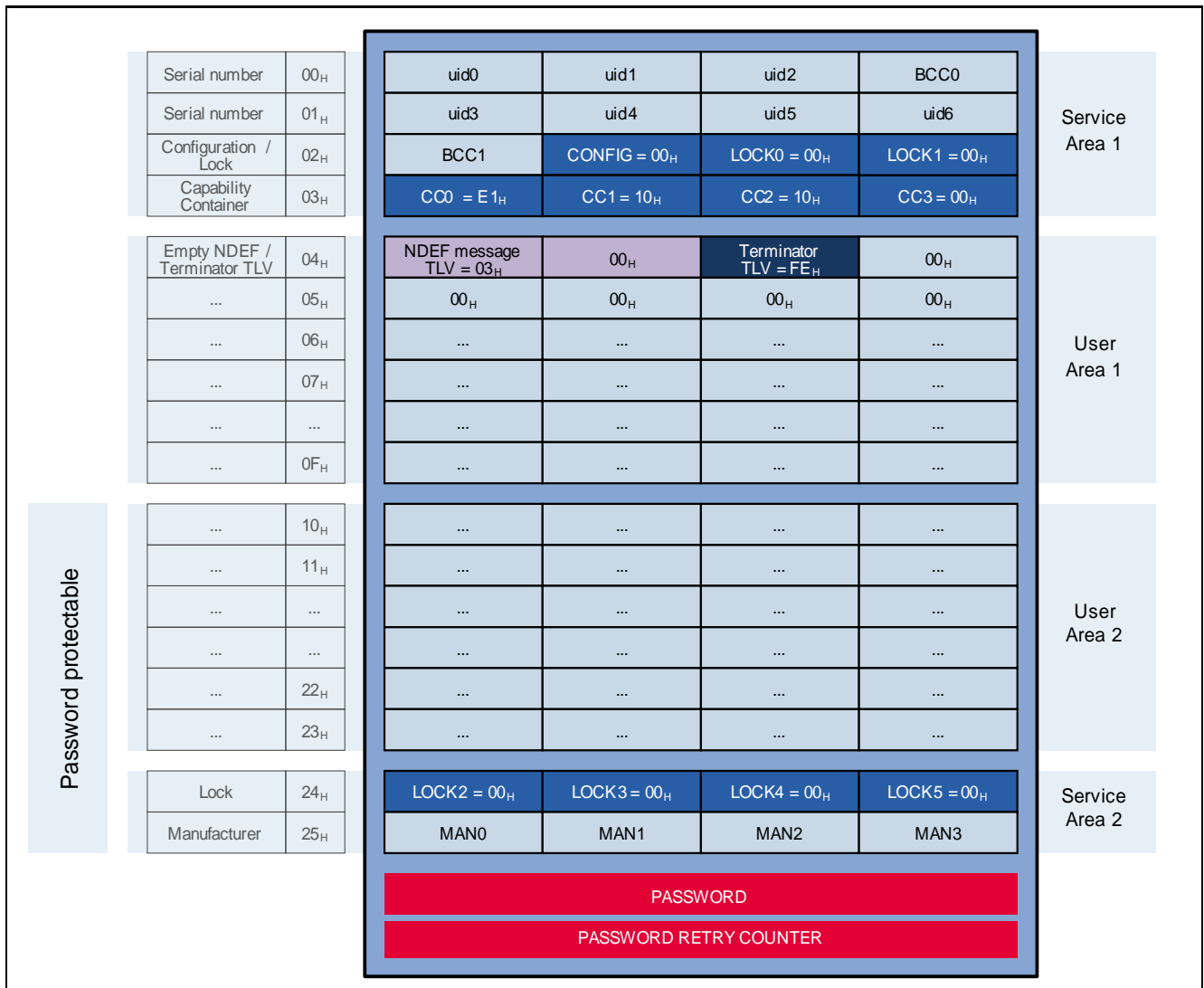

Figure 14 my-d™ move NFC Transport Configuration

- Service Area 1 contains
  - predefined UID, read-only
  - CONFIG, LOCK0 and LOCK1 set to 00<sub>H</sub>

- OTP0 - OTP3 contains the CAPABILITY CONTAINER (see [Table 9](#))
- User Area 1:
  - contains empty NDEF message TLV including Terminator TLV (= FE<sub>H</sub>) as indicated in [Table 10](#)
  - all other data bytes set to 00<sub>H</sub>
- User Area 2
  - all data bytes set to 00<sub>H</sub>
- Service Area 2 contains
  - LOCK2 - LOCK5 set to 00<sub>H</sub>
  - Manufacturer Data; read-only
- Password set to 00<sub>H</sub> 00<sub>H</sub> 00<sub>H</sub> 00<sub>H</sub>
- Password Retry Counter
  - deactivated by the setting of the CONFIG byte

**Table 9** Capability Container settings for my-d™ move and my-d™ move NFC

Chip Type	CC0	CC1 <sup>1)</sup>	CC2 <sup>2)</sup>	CC3
SLE 66R01PN	E1 <sub>H</sub>	10 <sub>H</sub> (may be changed to 11 <sub>H</sub> if needed)	10 <sub>H</sub>	00 <sub>H</sub>

- 1) my-d™ move and my-d™ move NFC also support Version 1.1 of the NFC Forum™ Type 2 Tag specification.
- 2) CC2 indicates the memory size of the data area of the Type 2 Tag; the given values represent the maximum values for the chips

**Table 10** defines the empty NDEF Message TLV (identified with the Tag field value of 03<sub>H</sub>). The Length field value is set to 00<sub>H</sub>; due to that the Value field is not present.

The Terminator TLV (FE<sub>H</sub>) is the last TLV block in the data area.

**Table 10** Empty NDEF message

NDEF Message TLV			Terminator TLV		
Tag field	Length field	Value field	Tag Field	Length field	Value field
03 <sub>H</sub>	00 <sub>H</sub>	-	FE <sub>H</sub>	-	-

*Note: The pre-configuration of SLE 66R01PN is nonreversible and the my-d™ move NFC cannot be overwritten and used as plain, standard my-d™ move anymore.*

## 5 Password

An issuer can protect the blocks above address 0F<sub>H</sub> with a 32 bit Write and/or Read/Write Password by enabling the password functionality.

The issuer can enable the password functionality by setting the Bit 1 (SP-W) of the Configuration Byte<sup>1)</sup> for Write Password access and/or bit 2 (SP-WR) of the Configuration Byte for Read/Write Password access (see [Chapter 4.2.2](#)).

The new configuration is activated after the next transition to IDLE/HALT state is executed.

The my-d™ move and my-d™ move NFC is delivered without Password protection i.e. default value of the SP-W and SP-WR bits is 0<sub>B</sub>.

**Table 11 Access Rights**

SP-WR	SP-W	Access Right
0 <sub>B</sub>	0 <sub>B</sub>	Read Plain / Write Plain (default setting)
0 <sub>B</sub>	1 <sub>B</sub>	Read Plain / Write Protected
1 <sub>B</sub>	X <sub>B</sub>	Read Protected / Write Protected

There is only one 32-bit Password value for both read and/or read/write access.

### 5.1 Password Block

The Password Block holds 32 bit of Password data and is stored in a memory location which is accessible with dedicated commands only. The initial value of the Password Block is 00<sub>H</sub> 00<sub>H</sub> 00<sub>H</sub> 00<sub>H</sub> and should be changed after delivery. The Set Password SPWD<sup>2)</sup> command is used to change the content of the Password Block.

- If the my-d™ move and my-d™ move NFC is not configured for a password protection i.e. bits for SP-W or SP-WR are not set, the Password Block will be overwritten with new Password data.
- If the my-d™ move and my-d™ move NFC is configured for password protection i.e. if SP-W and/or SP-WR bits are set, the Password Block will be overwritten with new Password data only after the chip has been successfully verified with the Access ACS<sup>3)</sup> command.

### 5.2 Password Retry Counter

A Password Retry Counter counts the number of incorrect accesses to a password protected my-d™ move and my-d™ move NFC. The number of incorrect accesses can be predefined by setting the bits [6:4] of the Configuration Byte. This number is called the initial value of the Password Retry Counter.

The Password Retry Counter is active if the number of incorrect accesses is higher than 0<sub>D</sub> i.e. bit[6:4] of the Configuration Byte are NOT all set to zero. The Write One Block (WR1B) command should be used to overwrite the Password Retry Counter value. The Initial value of the Password Retry Counter is active immediately after it is written.

To prevent any further changes on a predefined Password Retry Counter value it is recommended to lock the Configuration Byte. Once the Configuration Byte is locked, the status of an initial counter value is locked, i.e. are no further changes to these bits are possible.

The my-d™ move and my-d™ move NFC is delivered with a disabled Password Retry Counter i.e. the Initial value of the Password Retry Counter is equal to 000<sub>b</sub>. The maximum value of the Password Retry Counter is 7<sub>D</sub>, and valid values which activate the usage of the Password Retry Counter are in the range from 1<sub>D</sub> to 7<sub>D</sub>.

1) For more information about Configuration Byte see [Section 4.2.2](#).

2) For more information about SPWD command see [Section 8.2.6](#)

3) For more information about ACS command see [Section 8.2.7](#)

Figure 15 shows how to configure the Password functionality on the my-d™ move and my-d™ move NFC.

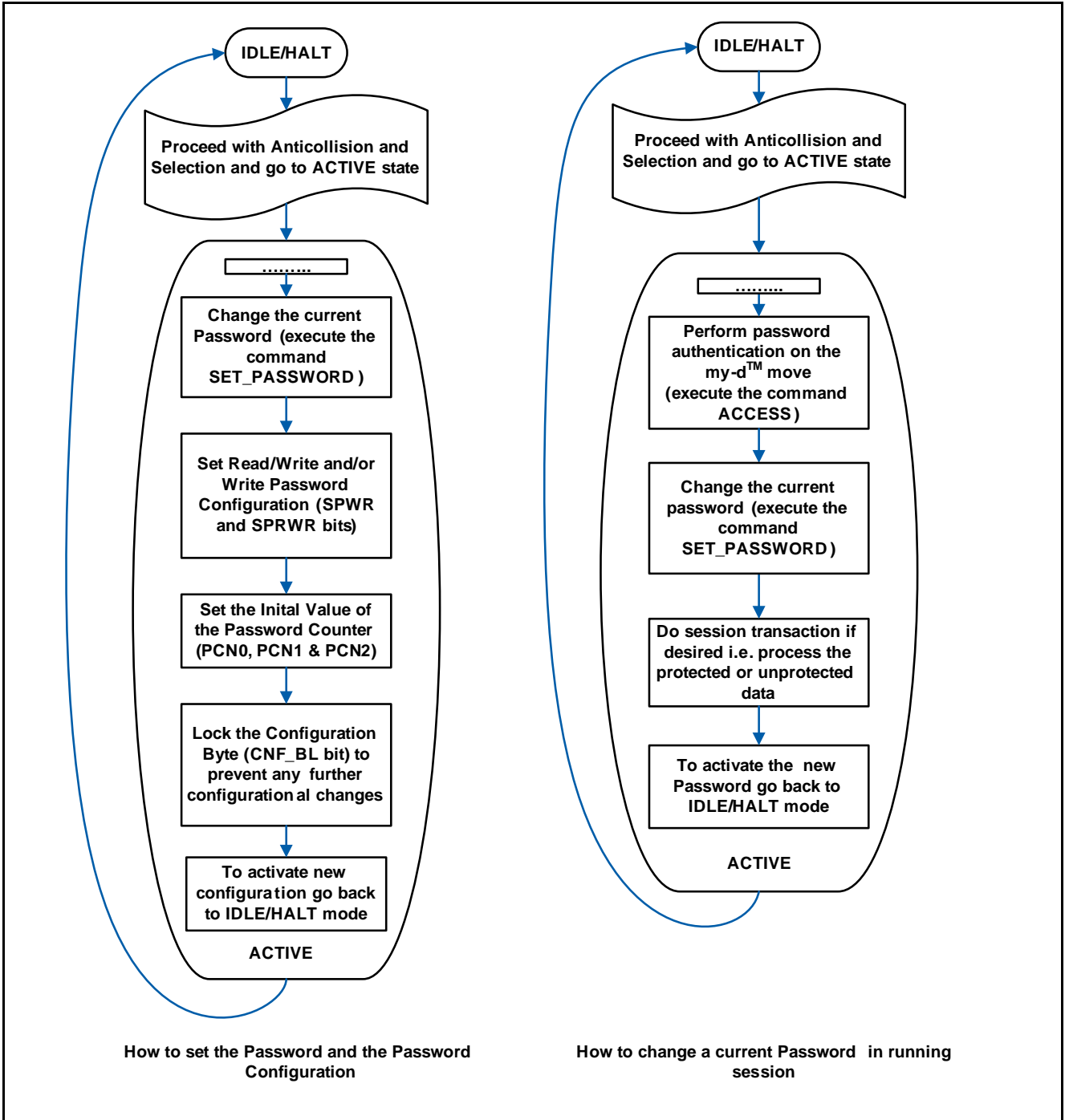

Figure 15 Password and Password Retry Counter configuration

### 5.3 Anti-tearing Mechanism for Password Retry Counter

The Password Retry Counter block is stored in the non-directly accessible part of the memory and for data protection reasons stored redundantly (anti-tearing). This mechanism prevents a stored value of being lost in case of a tearing event. This increases the level of data integrity and is transparent to the customer.

During the execution of the Access command the my-d™ move and my-d™ move NFC performs the following actions:

- compares the incoming Password and the Password stored in the my-d™ move and my-d™ move NFC
- Pass Retry Counter enabled:
  - resets the Password Retry Counter if the password matches. The my-d™ move and my-d™ move NFC responds with an ACK
  - increments the Password Retry Counter if the passwords do not match and if the Password Counter has not reached the highest possible value and my-d™ move and my-d™ move NFC responds with a NACK
  - if the Password Retry Counter has already reached the highest possible value (Initial Password Retry Counter value), then no further increase is done. The my-d™ move and my-d™ move NFC responds with a NACK.

Depending on the setting of the access bits the access to the memory above block 0F<sub>H</sub> is granted:

SP-W = 1<sub>B</sub>: read access only, no write access

SP-RW = 1<sub>B</sub>: no read and no write access

## 6 16-bit Value Counter Functionality

The Value Counter is a 16-bit value, which provides a mechanism to store some value (points, money...) on a my-d™ move and my-d™ move NFC chip. Normally it is only possible to decrement this value, however if certain conditions are met it is also possible to reload the counter to an arbitrary 16-bit value. The availability of the Value Counter in the my-d™ move and my-d™ move NFC is configurable by setting the bit 7 of the Configuration Byte.

### 6.1 Value Counter Format

If configured two 4-byte blocks, 22<sub>H</sub> and 23<sub>H</sub>, are reserved for the storage of the Value Counter value. The my-d™ move and my-d™ move NFC supports the detection of an interrupted or corrupted (teared) counter programming operation of the Value Counter. For the purpose the concept of **redundant saving** of the Value Counter as well as **temporarily double saving** of the Value Counter value during the programming process is implemented.

The redundant saving means, that the Value Counter is represented in the dedicated block by a 3-byte value: Counter LSB, inverted Counter LSB and Counter MSB. The fourth byte of the block is not used for the counter and carries 00<sub>H</sub> data. Counter LSB carries the lower value and Counter MSB carries the higher value of the Value Counter in hexadecimal representation.

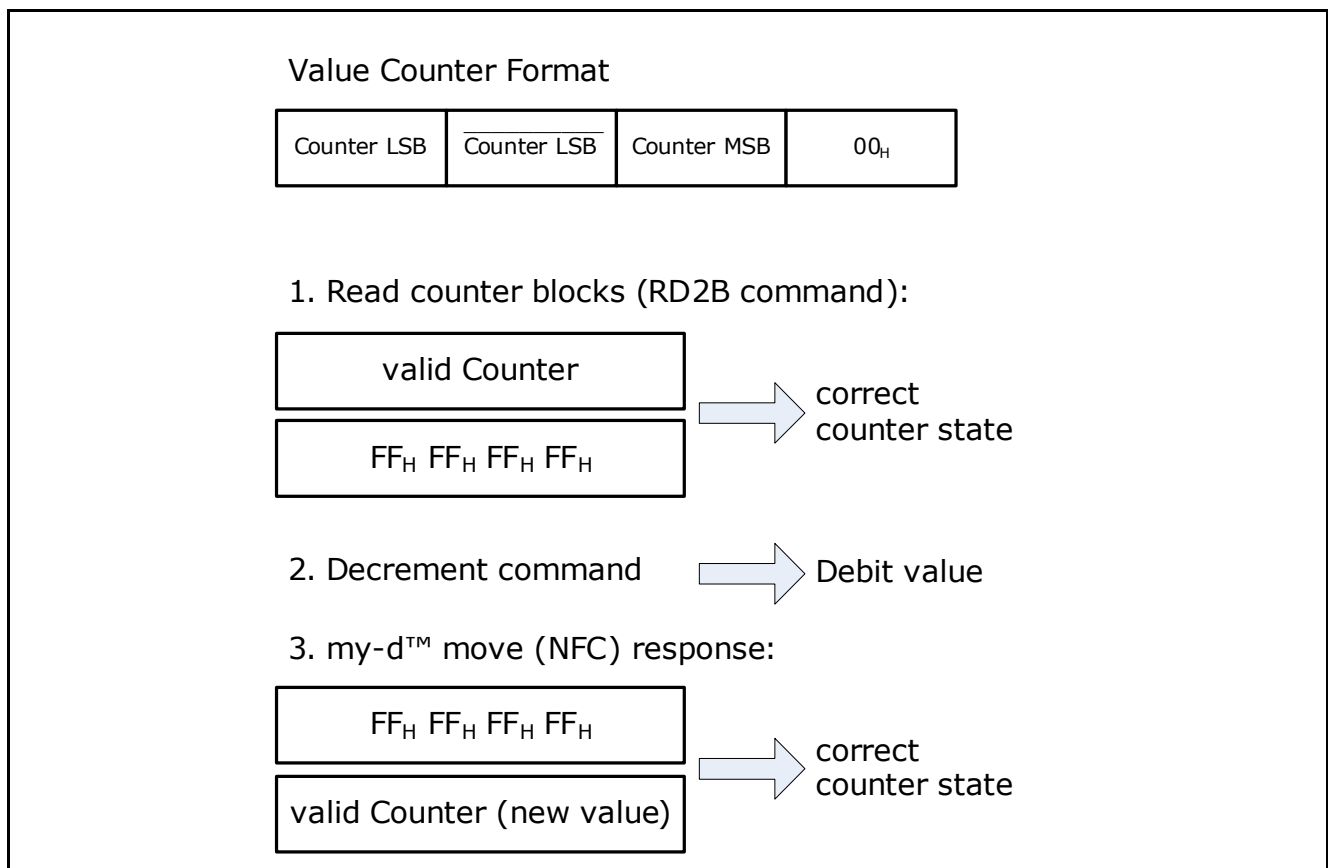

Figure 16 Value Counter - Principle

For an example: the value  $1000_D = 03E8_H \rightarrow$  Value Counter LS Byte =  $E8_H$  and Value Counter MS Byte =  $03_H$ . The Value Counter block looks like: Byte3 .. Byte0 =  $000317E8_H$ ; where  $00_H$  represents the data in byte3.

The temporarily double saving means that Value Counter is stored twice in two different memory blocks. **Figure 17** shows an example for the Value Counter representation and the decrementing of the value  $1000_D$  by  $1_D$ .

During the programming process of the new Value Counter, one block holds the current valid value and the other block is used to write the new counter value. At the end of programming cycle the current valid value, becomes an invalid value while it is erased (all bytes set to  $FF_H$ ) and the other one holds the new valid value.

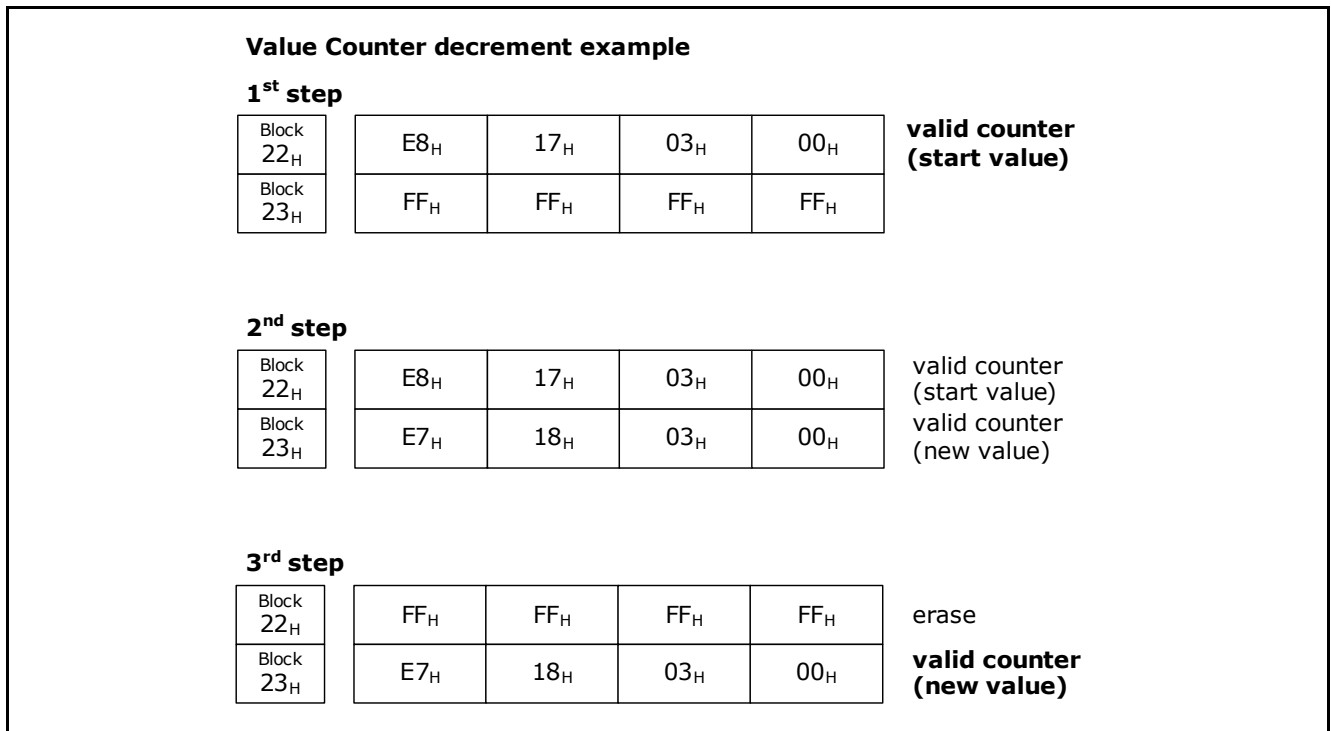

Figure 17 Value Counter decrement example

## 6.2 Loading and Reading of Value Counter

Loading of the Value Counter is done by either:

- Using WR2B command to address 22<sub>H</sub>:
  - [A1<sub>H</sub>] [22<sub>H</sub>] [CNT0<sub>H</sub>, CNT0<sub>H</sub>, CNT1<sub>H</sub>, 00<sub>H</sub>, FF<sub>H</sub>, FF<sub>H</sub>, FF<sub>H</sub>, FF<sub>H</sub>] [CRC0<sub>H</sub>, CRC1<sub>H</sub>]
- Using two WR1B commands to address 22<sub>H</sub> and 23<sub>H</sub>:
  - [A2<sub>H</sub>] [22<sub>H</sub>] [CNT0<sub>H</sub>, CNT0<sub>H</sub>, CNT1<sub>H</sub>, 00<sub>H</sub>] [CRC0<sub>H</sub>, CRC1<sub>H</sub>]
  - [A2<sub>H</sub>] [23<sub>H</sub>] [FF<sub>H</sub>, FF<sub>H</sub>, FF<sub>H</sub>, FF<sub>H</sub>] [CRC0<sub>H</sub>, CRC1<sub>H</sub>]
- It is also possible to use Compatibility Write command to initialize the counter, but this is not recommended.

It is crucial to initialize both Value Counter blocks for the correct counter operation.

Reading of Value Counter is done by either:

- Using RD2B command to addresses 22<sub>H</sub>:
  - [31<sub>H</sub>] [22<sub>H</sub>] [CRC0<sub>H</sub>, CRC1<sub>H</sub>]
- Using RD4B command to addresses 22<sub>H</sub>:
  - [30<sub>H</sub>] [22<sub>H</sub>] [CRC0<sub>H</sub>, CRC1<sub>H</sub>]
- Using DCR16 command with parameter 0000<sub>H</sub>:
  - [D0<sub>H</sub>] [0000<sub>H</sub>] [CRC0<sub>H</sub>, CRC1<sub>H</sub>]

### 6.3 Decrementing Value Counter and Anti-Tearing

The DCR16 command is used to decrement the Value Counter value. For more details refer to the command description in the [Chapter 8.2.8](#).

During the execution of the DCR16 command the my-d™ move and my-d™ move NFC performs following actions:

- Read both Value Counter blocks;
- Determine the correct valid Value Counter state. Therefore the values stored in blocks 22<sub>H</sub> and 23<sub>H</sub> are compared.
  - Normally one of the counter value blocks is erased or has an incorrect format and the other block holds the valid counter value.
  - If both counter values are correctly formatted, the higher value is chosen as the valid counter value. Note that at least one of the counters must be formatted correctly. Otherwise the Value Counter block is corrupted and no further decrement of the Value Counter is possible.
  - If both blocks carry invalid values (incorrect format) no further decrement of Value Counter is possible. The my-d™ move and my-d™ move NFC then responds with a NACK.
- Compares the received parameter and the valid counter value.
  - If the received parameter is equal or lower than the valid counter value the my-d™ move and my-d™ move NFC decrements the valid value by the received parameter, programs this value to the previous invalid value, erases the previous valid value and replies the new written value.
  - If the received parameter is higher than the valid value no decrement is possible and the my-d™ move and my-d™ move NFC responds with a NACK

### 6.4 Protection Mechanisms for the Value Counter

The my-d™ move and my-d™ move NFC offers some methods to protect the Value Counter. Following measures should be considered to prevent unauthorized changes.

- The Password:
  - If a Write Password is configured i.e. the bit SP-W is set, then the execution of Write commands (WR1B, WR2B or CPTWR) on Value Counter blocks (22<sub>H</sub> and 23<sub>H</sub>) is possible only after password verification.
  - If a Read/Write Password is configured i.e. the bit SP-WR is set, then the execution of Read commands RD2B and RD4B and Decrement command DCR16 on Value Counter (blocks 22<sub>H</sub> and 23<sub>H</sub>) is possible only after password verification.
- The Locking Mechanism for Value Counter:
  - After the configuration of the Value Counter it is strongly recommended to lock both blocks 22<sub>H</sub> and 23<sub>H</sub> in order to prevent the any unauthorized changes. The locking of blocks 22<sub>H</sub> and 23<sub>H</sub> is done by changing the locking information of the LOCK4 byte. If the bits 2 and 3 of the Lock4 byte are set then both Value Counter blocks are locked.
- Writing of the Value Counter block:
  - If blocks 22<sub>H</sub> and 23<sub>H</sub> are locked then no further overwriting of their values with write commands is possible. Note that if one of the blocks is locked and the other one is not, then it is possible to change the data of the unlocked block by using WR1B command. For this reason it is important to lock both blocks in order to prevent unintentional harm to Value Counter (i.e. unintentional overwriting or setting an incorrect value or a value with an incorrect format).
- Reading and Decrement of the Value Counter block:
  - If blocks 22<sub>H</sub> and 23<sub>H</sub> are locked then reading and decrementing is still possible. Note that depending on the chip configuration, password verification may be required.



## 7 Communication Principle

This chapter describes the functionality of the SLE 66R01P and SLE 66R01PN.

### 7.1 Communication between a card (PICC) and a reader (PCD)

It is recommended to read the ISO/IEC 14443-3 Type A and NFC Forum™ Type 2 Tag specifications in conjunction with this document in order to understand the communication protocol as well as the functionality of the SLE 66R01P and SLE 66R01PN as it is based on these specifications.

### 7.2 State Diagram

The SLE 66R01P and SLE 66R01PN is fully compliant to ISO/IEC 14443-3 Type A. All operations on this IC are initiated by an appropriate reader and controlled by the internal logic of the my-d™ move and my-d™ move NFC.

Prior to any memory access the card has to be selected according to the ISO/IEC 14443-3 Type A. If the my-d™ move and my-d™ move NFC is configured to be password protected, a password verification is required to access the memory.

The following figure presents the state diagram of SLE 66R01P and SLE 66R01PN.

If an unexpected command is received, the chip always returns to IDLE or HALT state, depending from which path it came from (the red paths in the state diagram).

#### 7.2.1 IDLE/HALT State

After Power On, the SLE 66R01P and SLE 66R01PN is in IDLE state.

If REQA or WUPA is executed in this state, the SLE 66R01P and SLE 66R01PN transits to READY1 state. Any other command is interpreted as an error and the chip stays in IDLE state without any response.

If the HLTA command is executed in ACTIVE/ACTIVE\* State, the SLE 66R01P and SLE 66R01PN will transit to HALT state. The HALT state can be left only if the chip receives a WUPA command. Any other command is interpreted as an error and the SLE 66R01P and SLE 66R01PN stays in the HALT state without any response.

#### 7.2.2 READY1/READY1\* State

In READY1/READY1\* state the first part of the UID can be resolved by using ISO/IEC 14443-3 Type A anticollision and/or Select commands.

After the Select command is executed properly the IC transits to READY2/READY2\* state in which the second part of the UID can be resolved. The answer to a Select command in READY1/READY1\* state is Select Acknowledge (SAK) for cascade level 1, which indicates that the UID is incomplete and the next cascade level has to be started to resolve the whole UID (see also ISO/IEC 14443-3 Type A).

However the SLE 66R01P and SLE 66R01PN can directly transit from READY1/ READY1\* state to ACTIVE/ACTIVE\* state if a read command RD2B or R4BD with a valid address is executed. Note if more than one SLE 66R01P and SLE 66R01PN is in the reader field, all ICs are selected after the execution of the read command, although all of them have different UIDs.

Any other command or any other interruption is interpreted as an error and the SLE 66R01P and SLE 66R01PN returns back to IDLE or HALT state without any response, depending from which state it has come from.

#### 7.2.3 READY2/READY2\* State

In READY2/READY2\* state the second part of the UID can be resolved using ISO/IEC 14443-3 Type A anticollision and/or Select commands.

After the Select command is executed properly the IC transits to ACTIVE/ACTIVE\* state in which memory can be accessed. The answer to a Select command in READY2/READY2\* state is SAK for cascade level 2, which indicates that the UID is complete and the selection process is finished.

However the SLE 66R01P and SLE 66R01PN can directly transit from READY2/READY2\* state to ACTIVE/ACTIVE\* state if a read command RD2B or RD4B is executed. Any valid block address can be used in the read command. Note if more than one SLE 66R01P and SLE 66R01PN is in the reader field, all ICs are selected after the execution of the read command, although all of them have different UIDs.

Any other command or any other interruption is interpreted as an error and the SLE 66R01P and SLE 66R01PN returns back to IDLE or HALT state without any response, depending from which part it has come from.

#### 7.2.4 ACTIVE/ACTIVE\* State

In the ACTIVE/ACTIVE\* state memory access commands can be executed.

If a SLE 66R01P and SLE 66R01PN is configured to have read/write or write password protection, a password verification is required to access the protected memory pages. In case of a successful password verification, read/write access to the whole memory is possible. If no verification is done or the password verification fails, the memory area above block 0F<sub>H</sub> is locked according to the access rights in the Configuration Byte.

The ACTIVE/ACTIVE\* state is left if the HLTA command is executed properly; the SLE 66R01P and SLE 66R01PN then transits to HALT state and waits until a WUPA command is received.

If any error command is received, the SLE 66R01P and SLE 66R01PN sends "No Response" (NR) or "Not Acknowledge" (NACK) and transits to IDLE or HALT state, depending from which state it has come from.

#### 7.2.5 HALT State

The HLTA command sets the SLE 66R01P and SLE 66R01PN in the HALT state. The SLE 66R01P and SLE 66R01PN sends no response to the HLTA command. In the HALT state the IC can be activated again by a Wake-UP command (WUPA).

Any other data received is interpreted as an error, the SLE 66R01P and SLE 66R01PN sends no response and remains in HALT state.

The exact behavior of a particular command in any of the states above is also described in the specific command description.

### 7.3 Start up

120  $\mu$ s after entering the powering field (after the field reset) the SLE 66R01P and SLE 66R01PN is ready to receive a command. If a command is send earlier, the response to this command is not defined.

#### 7.3.1 Start-up sequence of the SLE 66R01P and SLE 66R01PN

Each time after the execution of a REQA or WUPA, the SLE 66R01P and SLE 66R01PN reads the Configuration Byte and sets its internal states accordingly, see also the [Figure 18](#). This information is not updated until the next execution of REQA or WUPA commands in IDLE or HALT state even when the CONFIG byte is changed in the EEPROM.

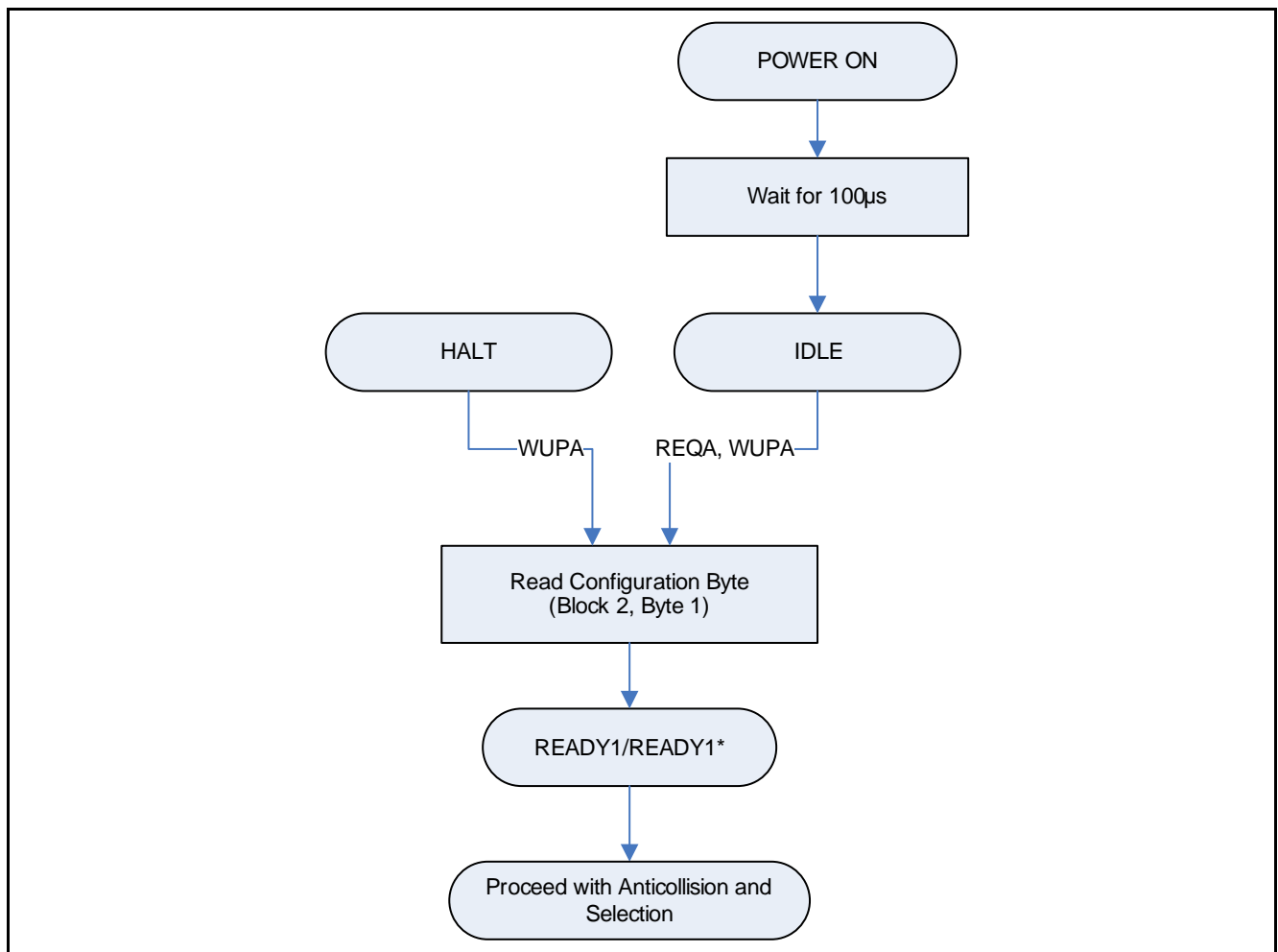

Figure 18 Start-up Sequence

### 7.4 Frame Delay Time

For information about Frame Delay Time (FDT), please refer to ISO/IEC 14443-3 Type A Specification.

Generally the FDT is measured between the last rising edge of the pause transmitted by the PCD and the falling edge of the first load modulation within the start bit transmitted by the my-d™ move and my-d™ move NFC. If more then one ISO/IEC 14443-3 Type A compatible chip is in the operating field of the reader all of them must respond in a synchronous way which is needed for the anticollision procedure.

For detailed timings see Table 1 of ISO/IEC 14443-3 Type A Specification.

Note: The response timing of a particular SLE 66R01P and SLE 66R01PN command is given in the specific command description. However, the timing values are rounded and are not on a grid according to the ISO/IEC 14443-3 Type A.

## 7.5 Error Handling

The SLE 66R01P and SLE 66R01PN responds to valid frames only. The table below describes the behavior for different error cases.

**Table 12 Behavior in case of an Error**

Current States	Command or Error	Response SLE 66R01P and SLE 66R01PN	Next State
IDLE/HALT READY1/READY1* READY2/READY2*	Invalid Opcode	NR <sup>1)</sup>	IDLE/HALT <sup>2)</sup>
	Parity, Miller Error, CRC	NR	IDLE/HALT
	Command too short or too long	NR	IDLE/HALT
	Invalid Address	NR	IDLE/HALT
	Other Errors	NR	IDLE/HALT
ACTIVE/ACTIVE*	Invalid Opcode	NR	IDLE/HALT
	Parity, Miller Error, CRC	NACK1	IDLE/HALT
	Command too short or too long	NR	IDLE/HALT
	Invalid Address	NACK0	IDLE/HALT
	Other Errors	NACK0	IDLE/HALT

1) RD4B and RD2B commands in READY1/READY1\* and READY2/READY2\* exceptionally behave as in ACTIVE/ACTIVE\* state.

2) The SLE 66R01P and SLE 66R01PN returns to IDLE or HALT state depending on the state where it has come from.

## 8 Command Set

### 8.1 Supported ISO/IEC 14443-3 Type A Command Set

The following table describes the ISO/IEC 14443-3 Type A command set which is supported by the SLE 66R01P and SLE 66R01PN.

For a detailed command description refer to the ISO/IEC 14443-3 Type A functional specification.

**Table 13 ISO/IEC 14443-3 Type A Command Set**

Command	Abbreviation	Op-Code	Description
Request A	REQA	26 <sub>H</sub>	Short Frame Command Type A request to all ISO/IEC 14443-3 Type A compatible chips in IDLE State
Wake Up A	WUPA	52 <sub>H</sub>	Short Frame Command, Type A Wake Up request to all ISO/IEC 14443-3 Type A compatible chips
Anticollision	AC	93 <sub>H</sub> NVB <sub>H</sub> 95 <sub>H</sub> NVB <sub>H</sub>	Cascade level 1 with the Number of Valid Bits Cascade level 2 with the Number of Valid Bits
Select	SELA	93 <sub>H</sub> 70 <sub>H</sub> , 95 <sub>H</sub> 70 <sub>H</sub>	Select the UID of Cascade level 1 Select the UID of Cascade level 2
HaltA	HLTA	50 <sub>H</sub>	Set a chip to a HALT State Important remark: The parameter field of the HLTA command represents the valid address range which is 00 <sub>H</sub> -25 <sub>H</sub> .

### 8.2 Memory Access Command Set

The command set of the SLE 66R01P and SLE 66R01PN comprises the NFC Forum™ Type 2 Tag commands as well as proprietary commands which are additionally implemented to increase data transaction time and increase the protection of the data stored in the memory.

The following table lists the memory access command set of the SLE 66R01P and SLE 66R01PN.

**Table 14 my-d™ move and my-d™ move NFC memory access command set**

Command	Abbreviation	Op-Code	Description
Read 4 Blocks <sup>1)</sup>	RD4B	30 <sub>H</sub>	This command reads 16 bytes data out of the memory starting from the specified address. A Roll-Back mechanism is implemented: - if block 0F <sub>H</sub> is reached the read continues from block 00 <sub>H</sub> - if block 25 <sub>H</sub> is reached the read continues from block 00 <sub>H</sub>
Write 1 Block <sup>2)</sup>	WR1B	A2 <sub>H</sub>	If write access is granted, this command programs 4 bytes data to the specified memory address.
Compatibility Write Command	CPTWR	A0 <sub>H</sub>	This command sends 16 bytes to the SLE 66R01P and SLE 66R01PN but writes only the first 4 bytes of the incoming data to the specified memory address.
Read 2 Blocks <sup>3)</sup>	RD2B	31 <sub>H</sub>	This command reads 8 bytes out of the memory, starting from the specified address. A Roll-Back mechanism is implemented: - if block 0F <sub>H</sub> is addressed, the read continues from block 00 <sub>H</sub> - if block 25 <sub>H</sub> is addressed, the read continues from block 00 <sub>H</sub>

**Table 14 my-d™ move and my-d™ move NFC memory access command set**

Command	Abbreviation	Op-Code	Description
Write 2 Blocks	WR2B	A1 <sub>H</sub>	If write access is granted, this command writes 8 bytes to the specified address memory. Note that the programming time is 4ms.
Set Password	SPWD	B1 <sub>H</sub>	This command sets the 4 byte password to the my-d™ move and my-d™ move NFC.
Access <sup>4)</sup>	ACS	B2 <sub>H</sub>	This command verifies the password of the my-d™ move my-d™ move NFC.
Decrement	DCR16	D0 <sub>H</sub>	This command decrements an existing Value Counter value to a lower value and writes the result to the Value Counter block.

1) NFC Forum™ Type 2 Tag Read Command

2) NFC Forum™ Type 2 Tag Write Command

3) By using RD2B and WR2B commands, total user memory of 128 bytes can be written and re-read within approximately 100 ms (excluding anti-collision and taking into account a short reader turnaround time, less than 100 μs).

4) If the my-d™ move and my-d™ move NFC is configured to use a write or read/write password, the appropriate memory access operations are possible only after password verification.

### 8.2.1 Read 4 Blocks (RD4B)

RD4B command reads 16 bytes data out of the memory starting from the specified address.

The Valid Address Range is 00<sub>H</sub> to 25<sub>H</sub>.

If any other address is specified the SLE 66R01P and SLE 66R01PN responds with a NACK. A roll back mechanism is implemented:

- if e.g. block 0E<sub>H</sub> is addressed blocks 0E<sub>H</sub>, 0F<sub>H</sub>, 00<sub>H</sub> and 01<sub>H</sub> are replied
- if e.g. block 25<sub>H</sub> is addressed blocks 25<sub>H</sub>, 00<sub>H</sub>, 01<sub>H</sub> and 02<sub>H</sub> are replied

**Table 15 Read 4 Blocks (RD4B)**

Command Length	Code	Parameter	Data	Integrity Mechanism	Response
4 bytes	30 <sub>H</sub>	Valid Address Range 00 <sub>H</sub> - 25 <sub>H</sub>	n.a.	2 bytes CRC (1 parity bit per byte)	16 bytes data + 2 bytes CRC or NACK or NR

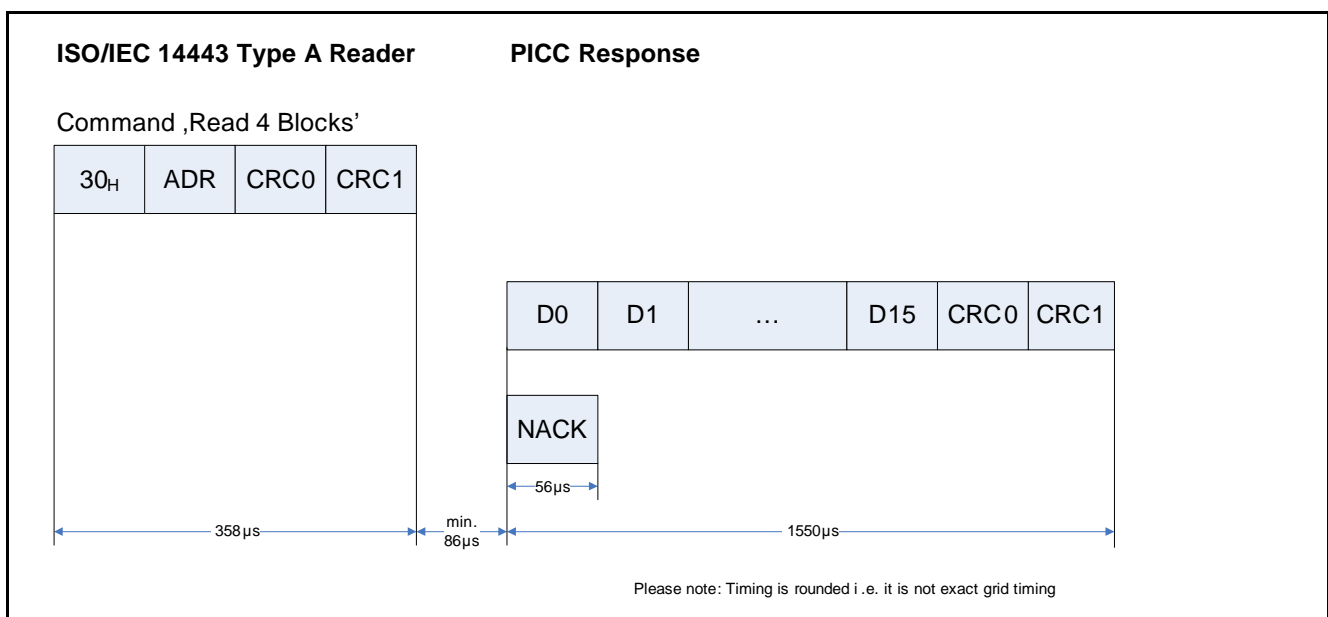

**Figure 19 Read 4 Blocks Command**

### 8.2.2 Write 1 Block (WR1B)

If the write access is granted the WR1B command is used to program 4 bytes of data to the specified address in the memory. This command should be used to program OTP block and Locking Bytes as well.

The Valid Address Range is from 02<sub>H</sub> to 24<sub>H</sub>. If any other address is specified the SLE 66R01P and SLE 66R01PN responds with a NACK.

**Table 16 Write 1 Block (WR1B)**

Command Length	Code	Parameter	Data	Integrity Mechanism	Response
8 bytes	A2 <sub>H</sub>	Valid Address Range 02 <sub>H</sub> - 24 <sub>H</sub>	4 bytes data	2 bytes CRC (1 parity bit per byte)	ACK or NACK or NR

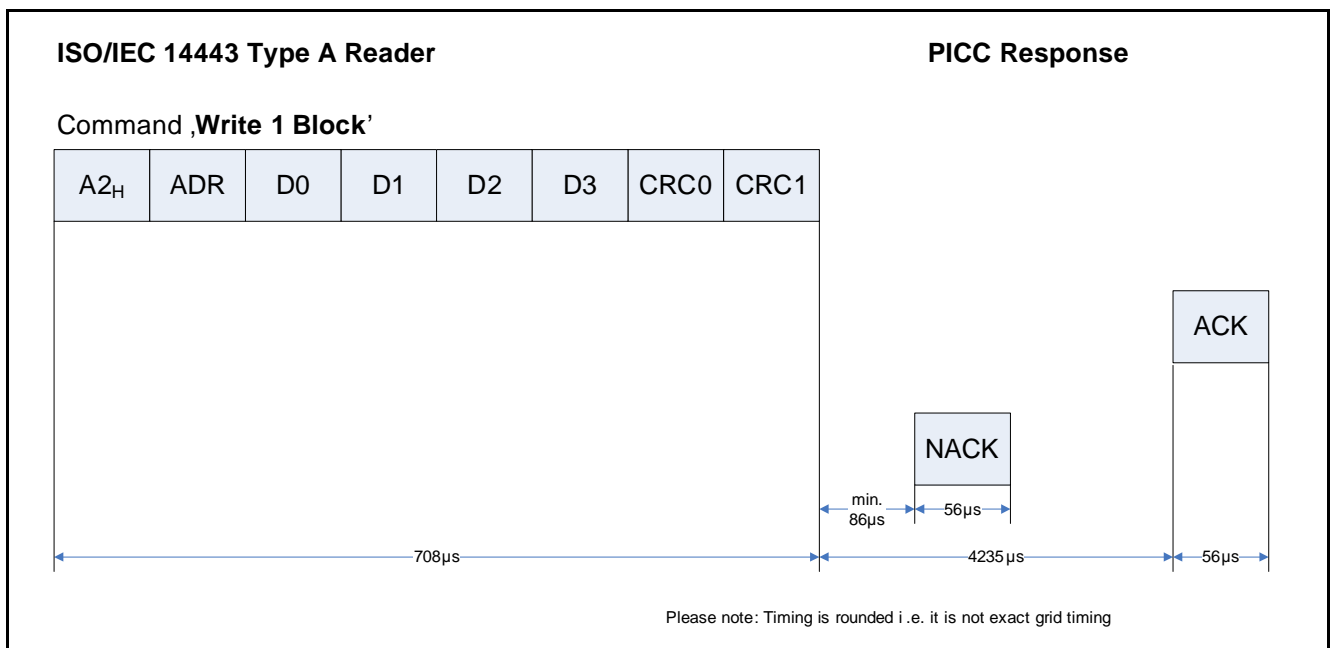

**Figure 20 Write 1 Block Command**



### 8.2.3 Compatibility Write Command (CPTWR)

If the write access is granted only the four least significant 4 bytes are written to the specified address. The remaining bytes will be ignored by the SLE 66R01P and SLE 66R01PN. It is recommended to set the remaining bytes 04<sub>H</sub>-0F<sub>H</sub> to 00<sub>H</sub>.

**Table 17 Compatibility Write (CPTWR)**

Command Length	Code	Parameter	Data	Integrity Mechanism	Response
20 bytes	A0 <sub>H</sub>	Valid Address Range 02 <sub>H</sub> - 24 <sub>H</sub>	16 bytes data	2 bytes CRC (1 parity bit per byte)	ACK or NACK or NR

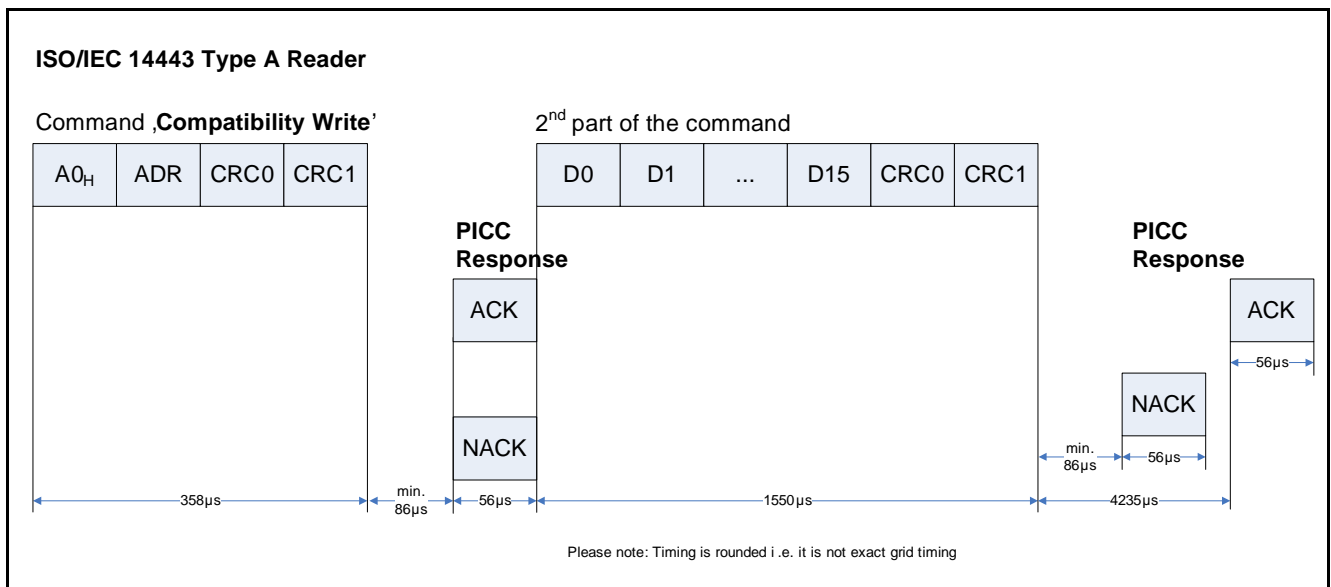

**Figure 21 Compatibility Write Command**

### 8.2.4 Read 2 Blocks (RD2B)

RD2B command reads 8 bytes out of the memory, starting from the specified address.

The Valid Address Range is from 00<sub>H</sub> to 25<sub>H</sub>. If any other address is specified the SLE 66R01P and SLE 66R01PN responds with a NACK. A roll back mechanism is implemented:

- if e.g. block 0F<sub>H</sub> is addressed blocks 0F<sub>H</sub> and 00<sub>H</sub> are replied.
- if e.g. block 25<sub>H</sub> is addressed blocks 25<sub>H</sub> and 00<sub>H</sub> are replied.

**Table 18 Read 2 Block (RD2B)**

Command Length	Code	Parameter	Data	Integrity Mechanism	Response
4 bytes	31 <sub>H</sub>	Valid Address Range 00 <sub>H</sub> - 25 <sub>H</sub>	n.a.	2 bytes CRC (1 parity bit per byte)	8 bytes data + 2 bytes data CRC or NACK

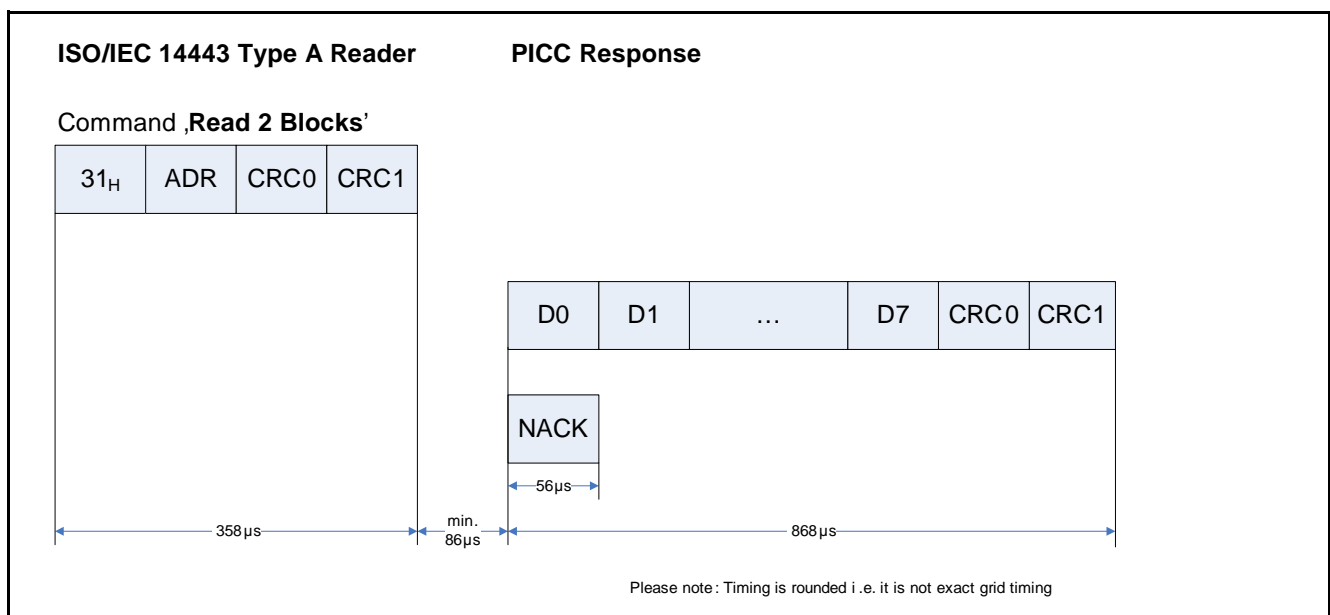

**Figure 22 Read 2 Blocks Command**

### 8.2.5 Write 2 Blocks (WR2B)

If write access is granted, i.e. if both addressed blocks are writable, the WR2B command is used to program two blocks (8 bytes of data) to the specified address in the memory.

The Valid Address Range is 04<sub>H</sub>-22<sub>H</sub>. Only even start addresses are allowed. If any other address is specified, the SLE 66R01P and SLE 66R01PN responds with a NACK.

The WR2B command has the same programming time (approximately 4ms) for writing 8 bytes as the WR1B command which writes 4 bytes of data to the specified memory.

Table 19 Write 2 Block (WR2B)

Command Length	Code	Parameter	Data	Integrity Mechanism	Response
12 bytes	A1 <sub>H</sub>	Valid Address Range 04 <sub>H</sub> - 22 <sub>H</sub> ; only even start addresses allowed	8 bytes data	2 bytes CRC (1 parity bit per byte)	ACK or NACK or NR

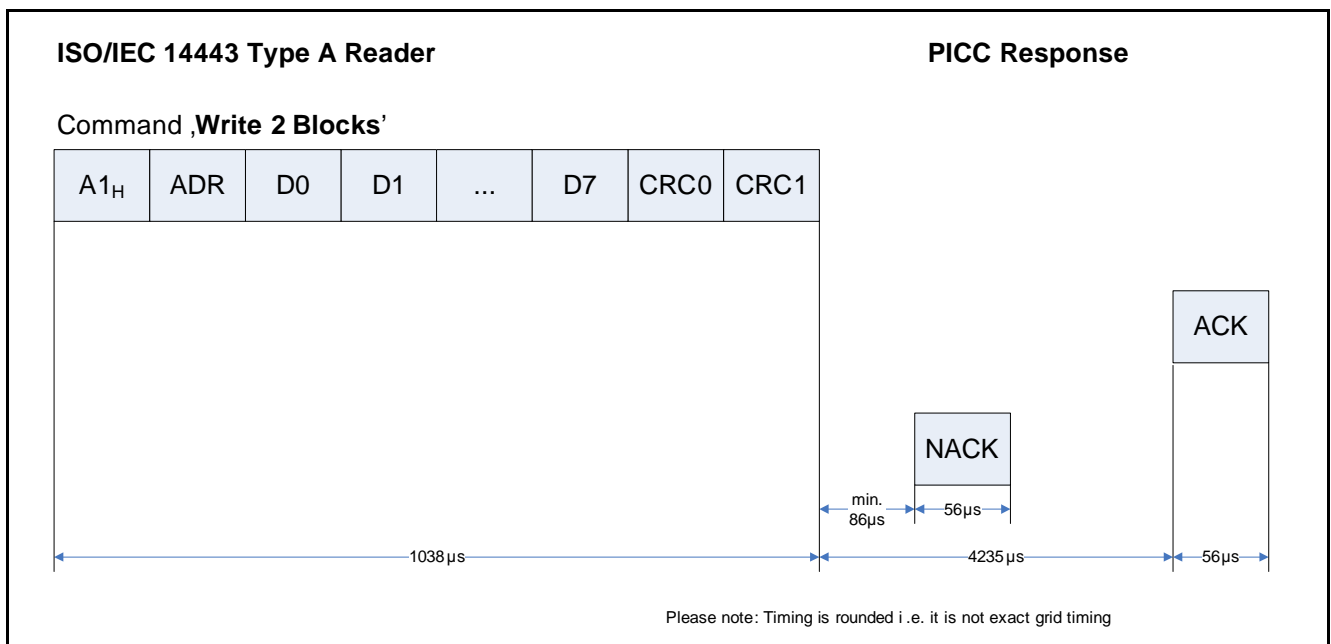

Figure 23 Write 2 Blocks Command

## 8.2.6 Set Password (SPWD)

The SPWD command writes a new 4 byte password to the dedicated password memory<sup>1)</sup>. The new written value is transmitted in the response.

The SPWD command is always active independently of password configuration. If the SLE 66R01P and SLE 66R01PN is configured for password protection, then the SPWD command can be executed only after a successful password verification.

**Table 20 Set Password (SPWD)**

Command Length	Code	Parameter	Data	Integrity Mechanism	Response
7 bytes	B1 <sub>H</sub>	n.a.	4 bytes data	2 bytes CRC (1 parity bit per byte)	4 bytes data + 2 bytes CRC or NACK or NR

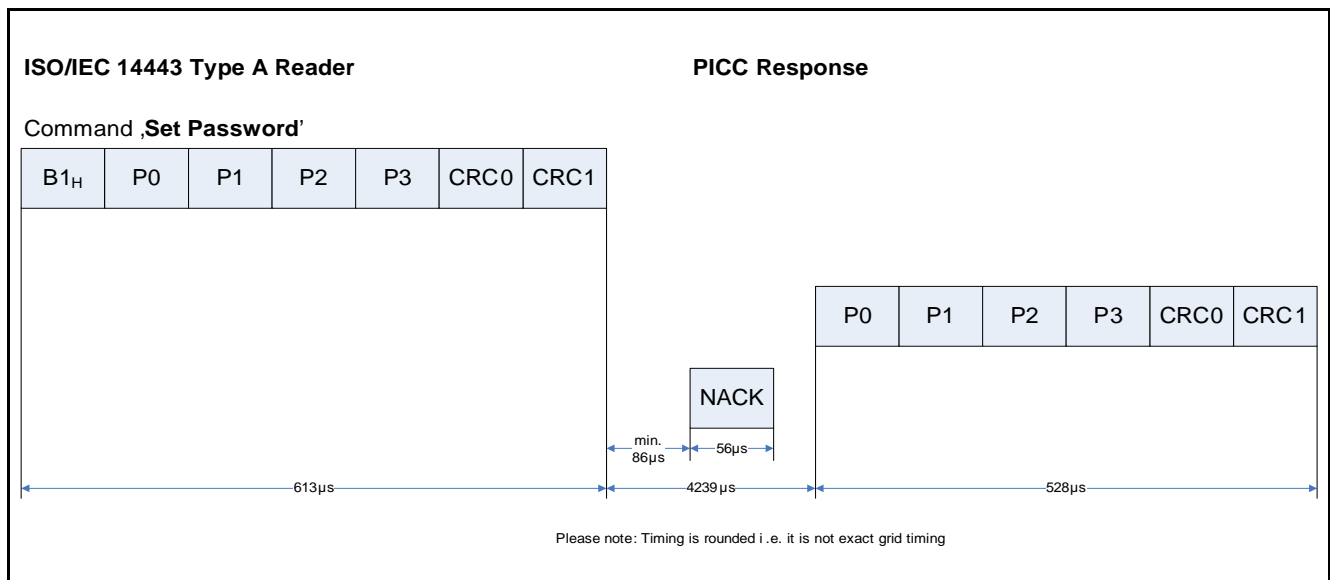

**Figure 24 Set Password Command**

**Table 21 SPWD - behaviour in error case**

Error / State	Idle/Halt	Ready	Active	Protected
Invalid Opcode	NR	NR	NR	NR
Parity, Miller	NR	NR	NACK1	NACK1
Command Length	NR	NR	NR	NR
CRC	NR	NR	NACK1	NACK1
The selected chip is protected by password	NR	NR	NACK0	n.a.
HV not OK	NR	NR	NR	NR

1) For more information about password please read [Chapter 5](#).

### 8.2.7 Access (ACS)

If the my-d™ move and my-d™ move NFC is configured for password protection<sup>1)</sup> the ACS command is used to perform a password verification. If the password verification is successful, memory access to blocks above block 0F<sub>H</sub> is granted according to the access rights given in the Configuration Byte.

Additionally, if the password counter is enabled, the number of unsuccessful password verifications is counted. The ACS command is always active independently on the Password and the Password Retry Counter configuration.

- If the Password Retry Counter is not enabled, the my-d™ move responds with ACK or NACK depending on the result of password comparison.
- If the Password Retry Counter is enabled, then depending on the result of password comparison the my-d™ move and my-d™ move NFC performs the following actions:
  - If the passwords do not match and the Password Retry Counter holds a lower value than its Initial value, the my-d™ move increments the Password Retry Counter and responds with a NACK.
  - If the passwords match and the Password Retry Counter holds a lower value than its Initial value, the my-d™ move resets the Password Retry Counter and responds with a ACK.
  - In any other case the my-d™ move responds with a NACK and limits access to blocks above block 0F<sub>H</sub> according to access rights stored in the Configuration Byte.

**Table 22 Access (ACS)**

Command Length	Code	Parameter	Data	Integrity Mechanism	Response
7 bytes	B2 <sub>H</sub>	n.a.	4 bytes data	2 bytes CRC (1 parity bit per byte)	ACK or NACK or NR

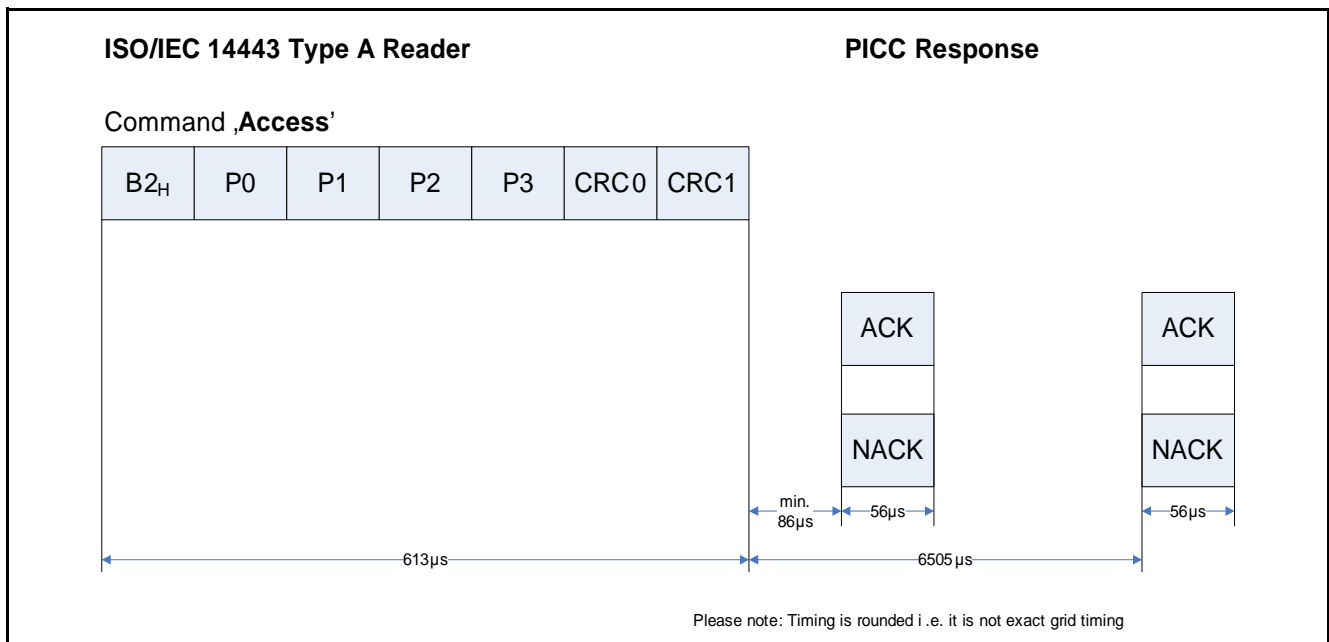

**Figure 25 Access Command**

1) For more information about password please read [Chapter 5](#).

The figure below shows the flow diagram of the Access command.

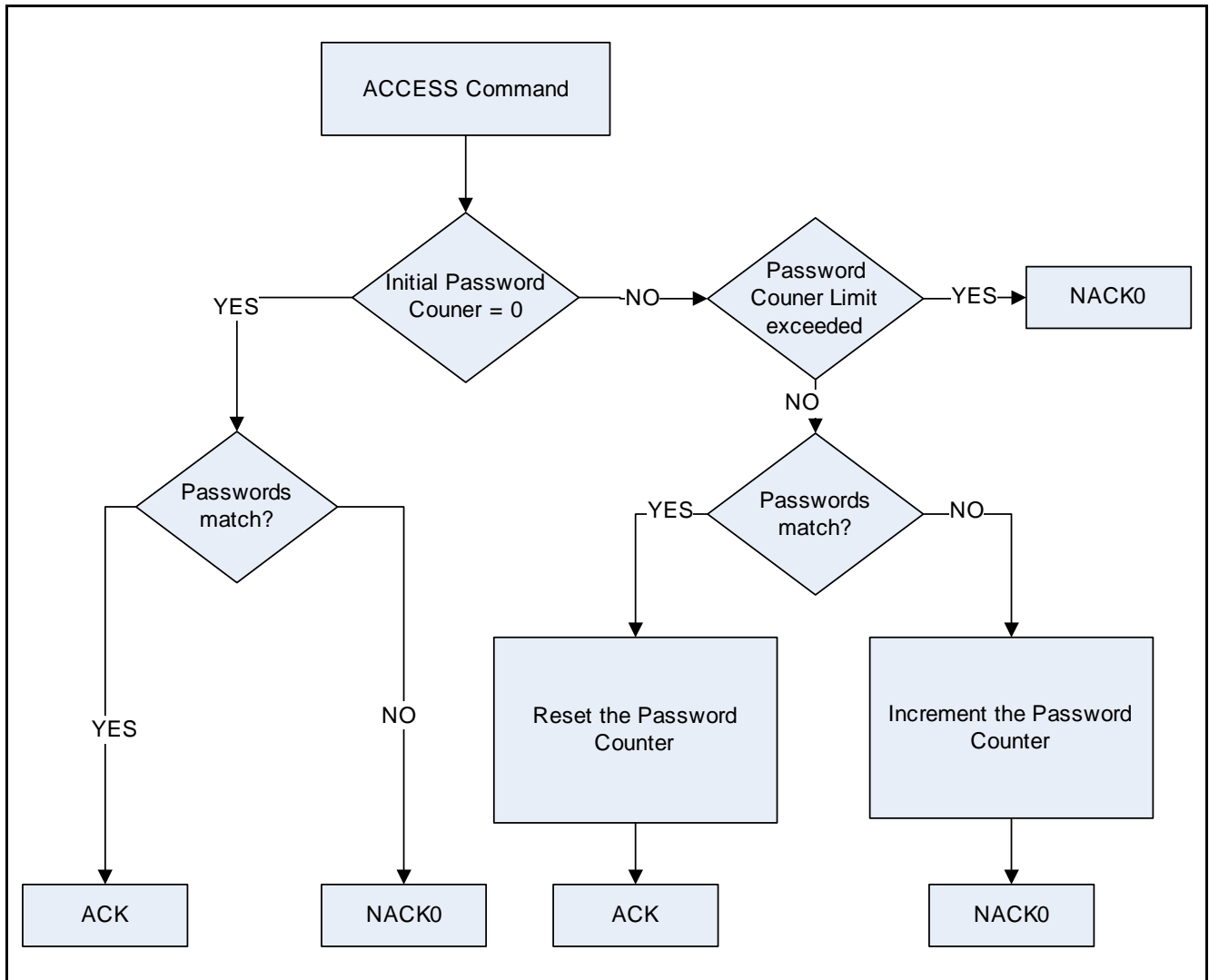

Figure 26 Flow Diagram of the ACS Command

Table 23 ACS - behaviour in error case

Error / State	Idle/Halt	Ready	Active	Protected
Invalid Opcode	NR	NR	NR	NR
Parity, Miller	NR	NR	NACK1	NACK1
Command Length	NR	NR	NR	NR
CRC	NR	NR	NACK1	NACK1
Password Counter limit exceeded	NR	NR	NACK0	NACK0
Passwords do not match	NR	NR	NACK0	n.a.
HV not OK	NR	NR	NR	NR

## 8.2.8 Decrement Command (DCR16)

The DCR16 command decrements the current Value Counter value by the received parameter and writes the new value to the Value Counter block. If this command is executed properly, the my-d™ move and my-d™ move NFC responds the new written value. Note that the parameter has to be lower or equal to the current Value Counter value.

**Table 24 Decrement (DCR16)**

Command Length	Code	Parameter	Data	Integrity Mechanism	Response
5 bytes	D0 <sub>H</sub>	2 bytes; LSByte = CNT0 MSByte = CNT1	n.a.	2 bytes CRC 1 parity bit per byte	<ul style="list-style-type: none"> <li>If the parameter is lower or equal to the current Value Counter Value, the response is the new decremented value: 2 bytes data + 2 bytes CRC</li> <li>If the parameter is 0000<sub>H</sub> the response is the current Value Counter value</li> <li>If the parameter is higher than the current Value Counter value the response is a NACK</li> </ul>

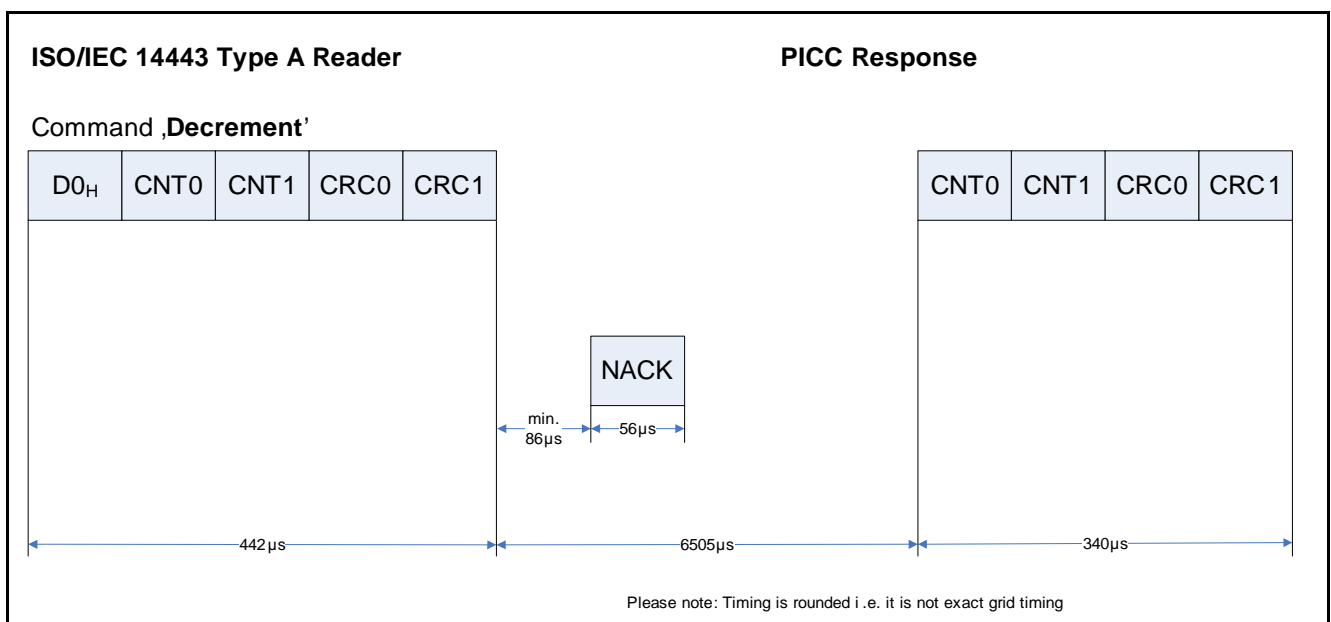

**Figure 27 Decrement Command**

After receiving the correct DCR16 command, the my-d™ move and my-d™ move NFC performs the following actions:

- checks the format of the current Value Counter by reading blocks 22<sub>H</sub> and 23<sub>H</sub>;
- determines the valid and the invalid Value Counter value;
- decrements the current valid value by the received parameter;
- expands the result to the correct Value Counter format;
- writes the new Value Counter value, in the correct format, to the previously determined invalid block
- erases the current valid Value Counter value to FF<sub>H</sub> FF<sub>H</sub> FF<sub>H</sub> FF<sub>H</sub>

In case of a successful programming of a Value Counter value, the my-d™ move and my-d™ move NFC sends the new written value of the Value Counter block back. If the programming was unsuccessful (due to insufficient power) "No Response" is replied.

In case of any other logical error or if the Value Counter block is corrupted (i.e. both blocks have an incorrect format) a NACK is replied.

**Table 25 DCR16 - behaviour in error case**

Error / State	Idle/Halt	Ready	Active	Protected
Invalid Opcode	NR	NR	NR	NR
Parity, Miller	NR	NR	NACK1	NACK1
Command Length	NR	NR	NR	NR
CRC	NR	NR	NACK1	NACK1
VCNTR16 not enabled	NR	NR	NACK0	NACK0
The selected chip is protected by password	NR	NR	NACK0	NACK0
Both counter blocks corrupted	NR	NR	NACK0	NACK0
Current VCNTR16 to low	NR	NR	NR	NR
HV not OK	NR	NR	NR	NR

The figure below presents the flow diagram of the Decrement command.

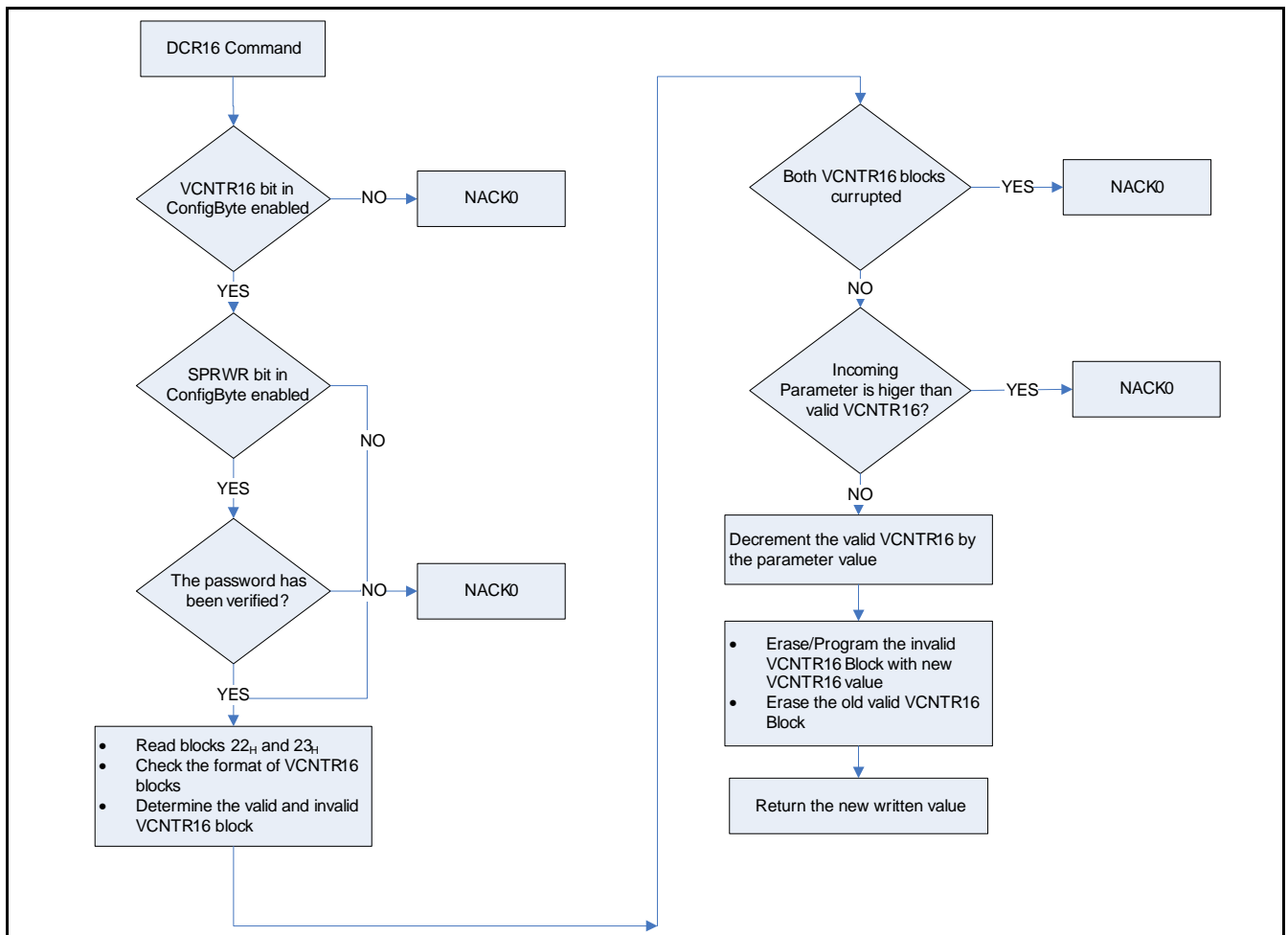

**Figure 28 Decrement Command flow**



### 8.2.9 HLTA command

The HLTA command is used to set the SLE 66R01P and SLE 66R01PN into the HALT state. The HALT State allows users to separate already identified chips. Contrary to the definition in the ISO/IEC 14443-3 Type A standard, the SLE 66R01P and SLE 66R01PN accept as a parameter the whole address range of 00<sub>H</sub> to 25<sub>H</sub> with correct CRC for a proper execution of a HLTA command.

**Table 26** Halt (HLTA)

Command Length	Code	Parameter	Data	Integrity Mechanism	Response
4 bytes	50 <sub>H</sub>	Valid Address Range 00 <sub>H</sub> - 25 <sub>H</sub>	n.a.	2 bytes CRC 1 parity bit per byte	NACK or NR

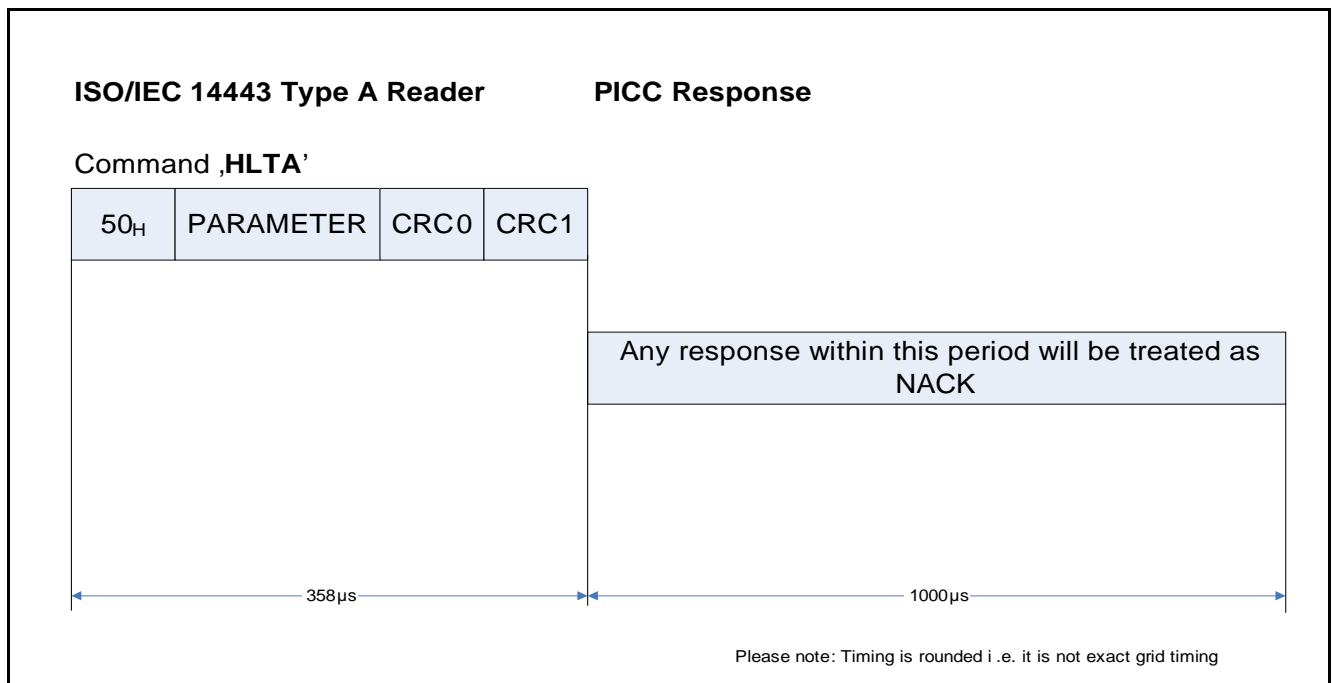

**Figure 29** HLTA Command

### 8.3 my-d™ move and my-d™ move NFC responses

Following sections list valid responses of the SLE 66R01P and SLE 66R01PN

#### 8.3.1 Command responses

The Acknowledge (ACK) and Not-Acknowledge (NACK) are command responses of the SLE 66R01P and SLE 66R01PN.

**Table 27 ACK and NACK as responses**

Response	Code (4 bits)	Integrity Mechanism
ACK	A <sub>H</sub>	n.a.
NACK0	0 <sub>H</sub>	n.a.
NACK1	1 <sub>H</sub>	n.a.
NR <sup>1)</sup>	n.a.	n.a.

1) Depending on the current state, the SLE 66R01P and SLE 66R01PN does not respond to some errors.

The response code is A<sub>H</sub> for ACK and 0<sub>H</sub> or 1<sub>H</sub> for NACK. The ACK and NACK are sent as 4 bit response with no CRC and/or parity.

#### 8.3.2 my-d™ move and my-d™ move NFC identification data

During the anti-collision the SLE 66R01P and SLE 66R01PN sends responses to the REQA and SEL commands.

**Table 28 Summary of SLE 66R01P and SLE 66R01PN identification data**

Code	Data	Description
ATQA	0044 <sub>H</sub>	Answer to Request, response to REQA and WUPA command, hard coded 2 bytes. Indicates a double-size UID.
SAK (cascade level 1)	04 <sub>H</sub>	Select Acknowledge answer to selection of 1 <sup>st</sup> cascade level. Indicates that the UID is incomplete.
SAK (cascade level 2)	00 <sub>H</sub>	Select Acknowledge answer to selection of 2 <sup>nd</sup> cascade level. Indicates that the UID is complete.
CT	88 <sub>H</sub>	Cascade Tag Indicates that UID is not single size UID.

## 9 Operational Characteristics

The listed characteristics are ensured over the operating range of the integrated circuit. Typical characteristics specify mean values expected over the production spread. If not otherwise specified, typical characteristics apply at  $T_{\text{ambient}} = 25^{\circ}\text{C}$  and the given supply voltage.

### 9.1 Electrical Characteristics

$f_{\text{CAR}} = 13.56$  MHz sinusoidal waveform, voltages refer to VSS.

**Table 29** Electrical Characteristics

Parameter	Symbol	Values			Unit	Note / Test Condition
		Min.	Typ.	Max.		
Chip input capacitance $L_A$ - $L_B$	$C_{\text{IN}}$	16.15	17	17.85	pF	$V_{\text{AB peak}} = 3.0$ V, $f_{\text{CAR}} = 13.56$ MHz, $T_{\text{ambient}} = 25$ °C
Chip load resistance $L_A$ - $L_B$	$R_{\text{IN}}$	3	4.5	6	kΩ	$V_{\text{AB peak}} = 3.0$ V, $f_{\text{CAR}} = 13.56$ MHz, $T_{\text{ambient}} = 25$ °C
Endurance (erase/write cycles) <sup>1)</sup>		$10^4$				–
Data retention <sup>1)</sup>		5			years	
EEPROM Erase and Write time	$t_{\text{prog}}$			3.8	ms	Combined erase + write; excluding time for command / response transfer between interrogator and chip, $T_{\text{ambient}} = 25$ °C
ESD Protection voltage ( $L_A$ , $L_B$ pins)	$V_{\text{ESD}}$	2			kV	JEDEC STD EIA / JESD22 A114-B
Ambient temperature	$T_{\text{ambient}}$	-25		+70	°C	for chip
Junction temperature	$T_{\text{junction}}$	-25		+110	°C	for chip

1) Values are temperature dependent

## 9.2 Absolute Maximum Ratings

Stresses above the maximum values listed here may cause permanent damage to the device. Exposure to absolute maximum rating conditions for extended periods may affect device reliability, including EEPROM data retention and erase/write endurance. Maximum ratings are absolute ratings; exceeding only one of these values may cause irreversible damage to the integrated circuit. This is a stress rating only and functional operation of the device at these or any other conditions above those indicated in the operational sections of this data sheet is not implied.

**Table 30 Absolute Maximum Ratings**

Parameter	Symbol	Values			Unit	Note / Test Condition
		Min.	Typ.	Max.		
Input peak voltage between $L_A$ - $L_B$	$V_{INpeak}$			6	$V_{peak}$	
Input current through $L_A$ - $L_B$	$I_{IN}$			30	mA	
Storage temperature	$T_{storage}$	-40		+125	°C	

[www.infineon.com](http://www.infineon.com)

Published by Infineon Technologies AG